

TSOI
KOBUS
DESIGN

HamiltonAnderson

SDG
Architects + Planners

fishbeck

BRA

DLZ

Sheet Author: HJR

MARK DATE DESCRIPTION

Project Number: 10350997

Key Plan

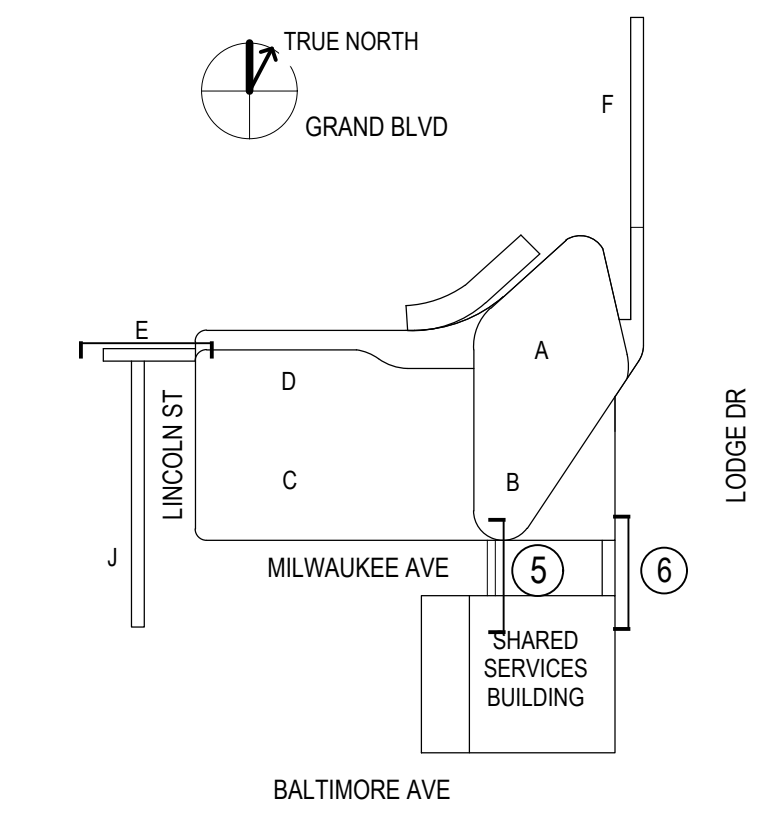

PRELIMINARY
FOR INFORMATION ONLY

Sheet Name

ROW ENCROACHMENT
EXHIBITS: 5-6

Scale: 1/8" = 1'
Sheet Number

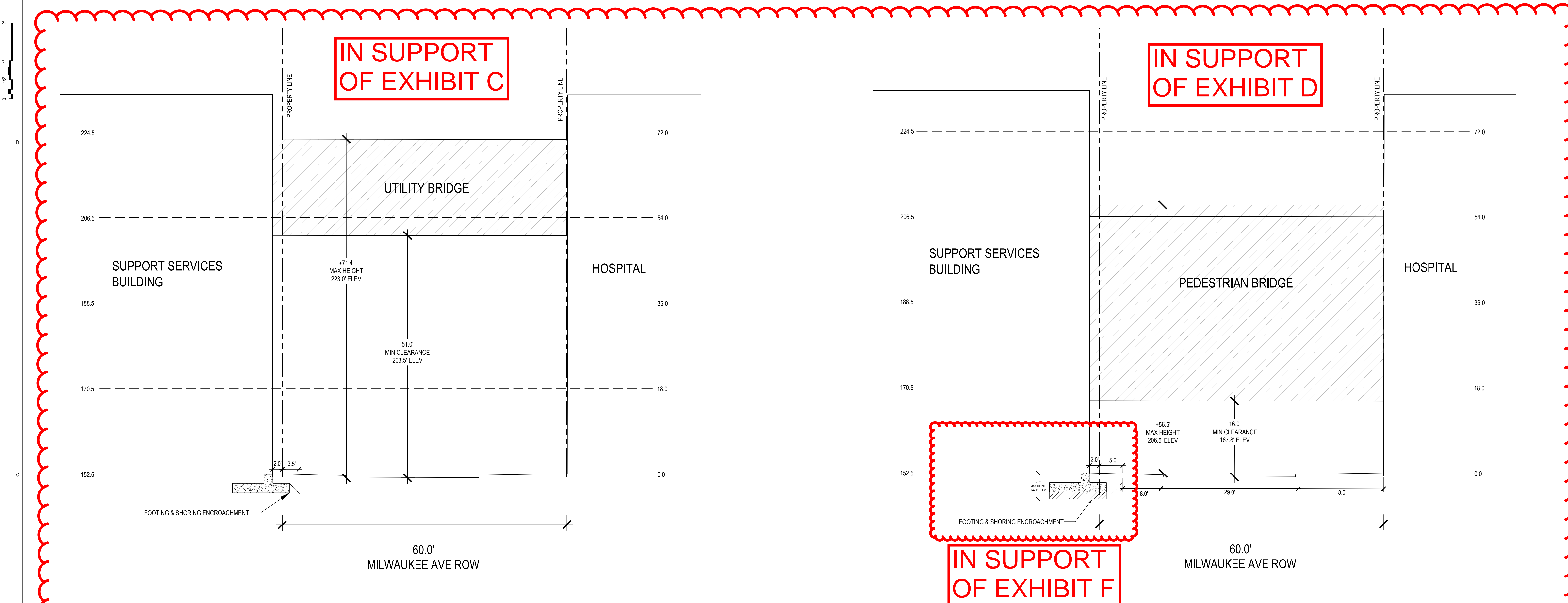

5 SUPPORT SERVICE BUILDING UTILITY BRIDGE - MILWAUKEE AVE @ MID-BLOCK

6 SUPPORT SERVICES BUILDING 2-STORY PEDESTRIAN BRIDGE - MILWAUKEE AVE EAST

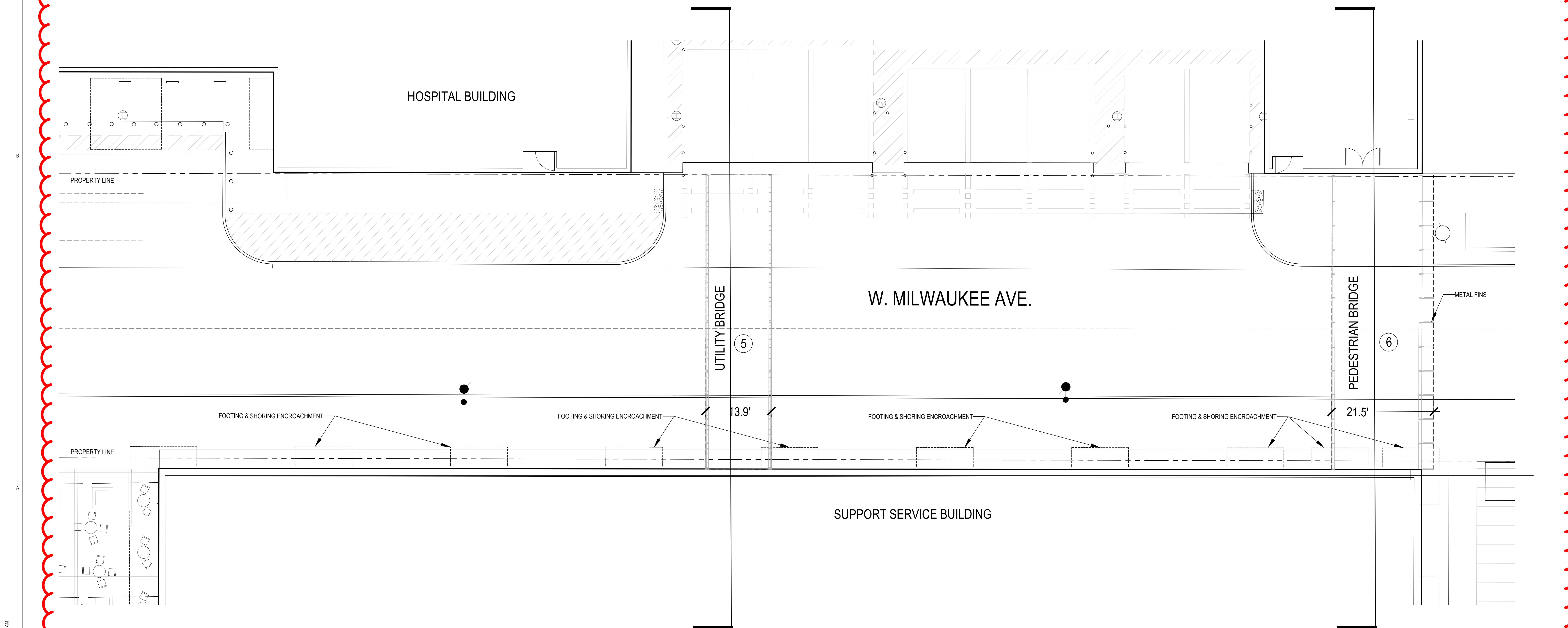

7 SUPPORT SERVICES BUILDING FRONTAGE ALONG MILWAUKEE AVE

7/18/2024 10:22:14 AM

6/10/2024 10:14:14 AM - Added Door to 1030997 - Henry Ford Hospital 1030997 - A4-PA-G-CELL-0303-H
 6/30/2024 - External Elevations

EXTERIOR SYMBOLS	
BMV	EXTERIOR WALL ASSEMBLY TYPE CURTAINWALL SYSTEM TYPE
GLW	GLAZING / SPANDREL PANEL TYPE
LVT	LOUVER TYPE
W1	EXTERIOR WINDOW ASSEMBLY, REFER TO A-600 SERIES

SHEET NOTES	
1.	REFER TO SHEET A-001 FOR SYMBOLS & GENERAL NOTES.
2.	REFER TO SHEETS A-500 & A-501 FOR EXTERIOR WALL AND ROOF TYPE ASSEMBLIES.
3.	EXTERIOR WALLS DIMENSIONS ARE TO FACE OF CURTAINWALL OR FACE OF MASONRY, UNO.

Destination: GRAND
 HENRY FORD HEALTH+
 Henry Ford Hospital
 Shared Services Building
 West Grand Blvd.
 Detroit, MI 48202



Sheet Author	HDR	
MARK	DATE	DESCRIPTION
	10/05/23	SSB SCHEMATIC DESIGN / EQ 1
	12/12/23	SSB EQ 2
	06/14/24	SSB DETAILED DESIGN

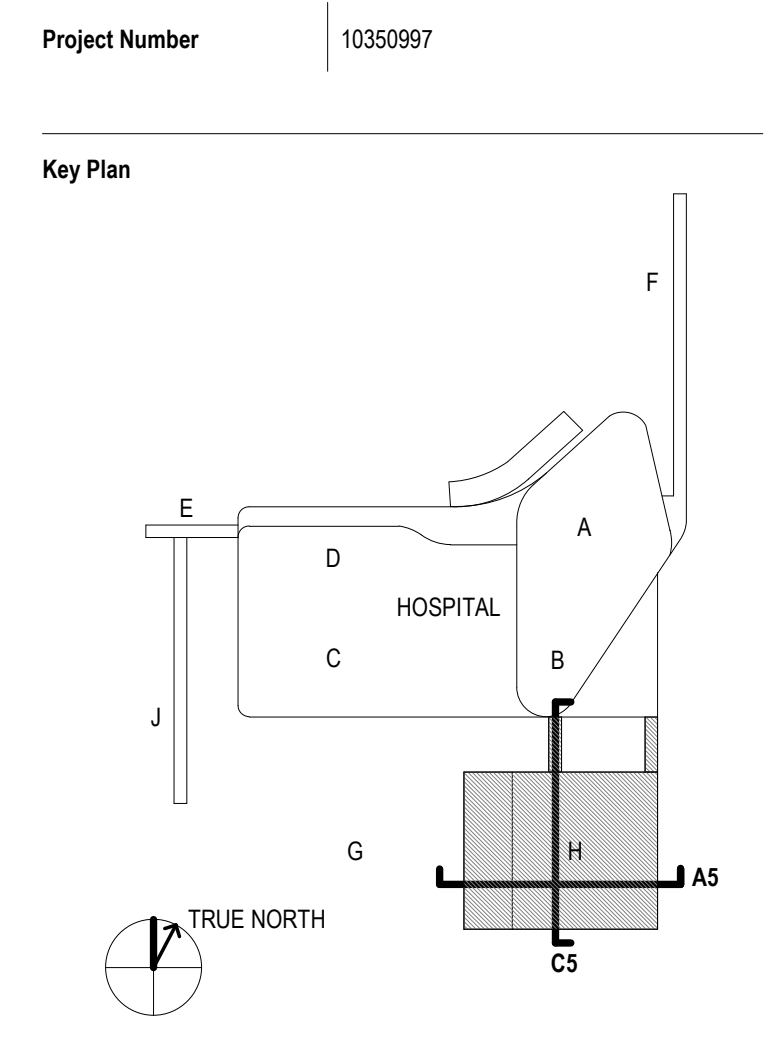

PRELIMINARY
 NOT FOR CONSTRUCTION

Sheet Name
BUILDING SECTIONS

Scale
 As indicated
 Sheet Number
A.302

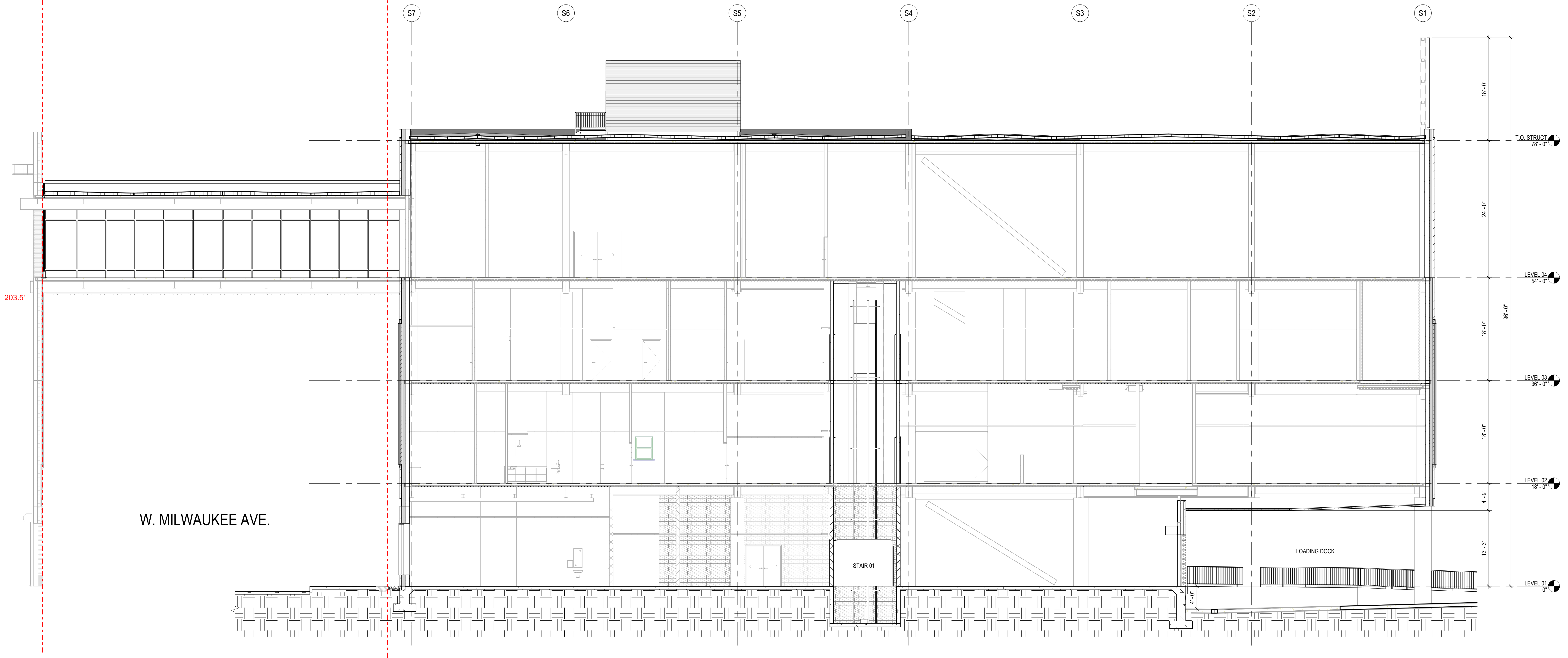

C5 BUILDING SECTION 4
 1/8" = 1'-0"

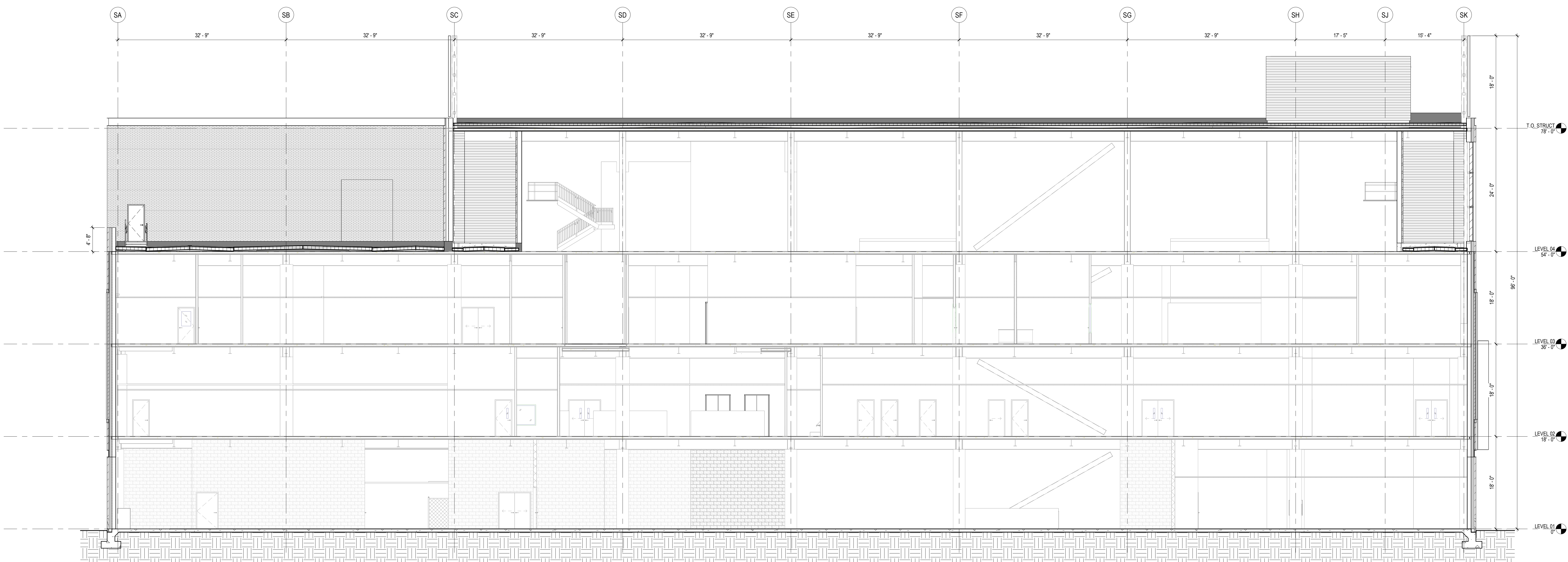

A5 BUILDING SECTION 3
 1/8" = 1'-0"

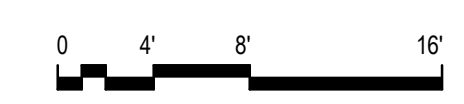

6/10/2024 12:26:24 AM - Added Door to 020209 Henry Ford Hospital 020209 WPA-G-CELL CSB-H
 6/30/2024 12:26:24 AM - Added Door to 020209 Henry Ford Hospital 020209 WPA-G-CELL CSB-H

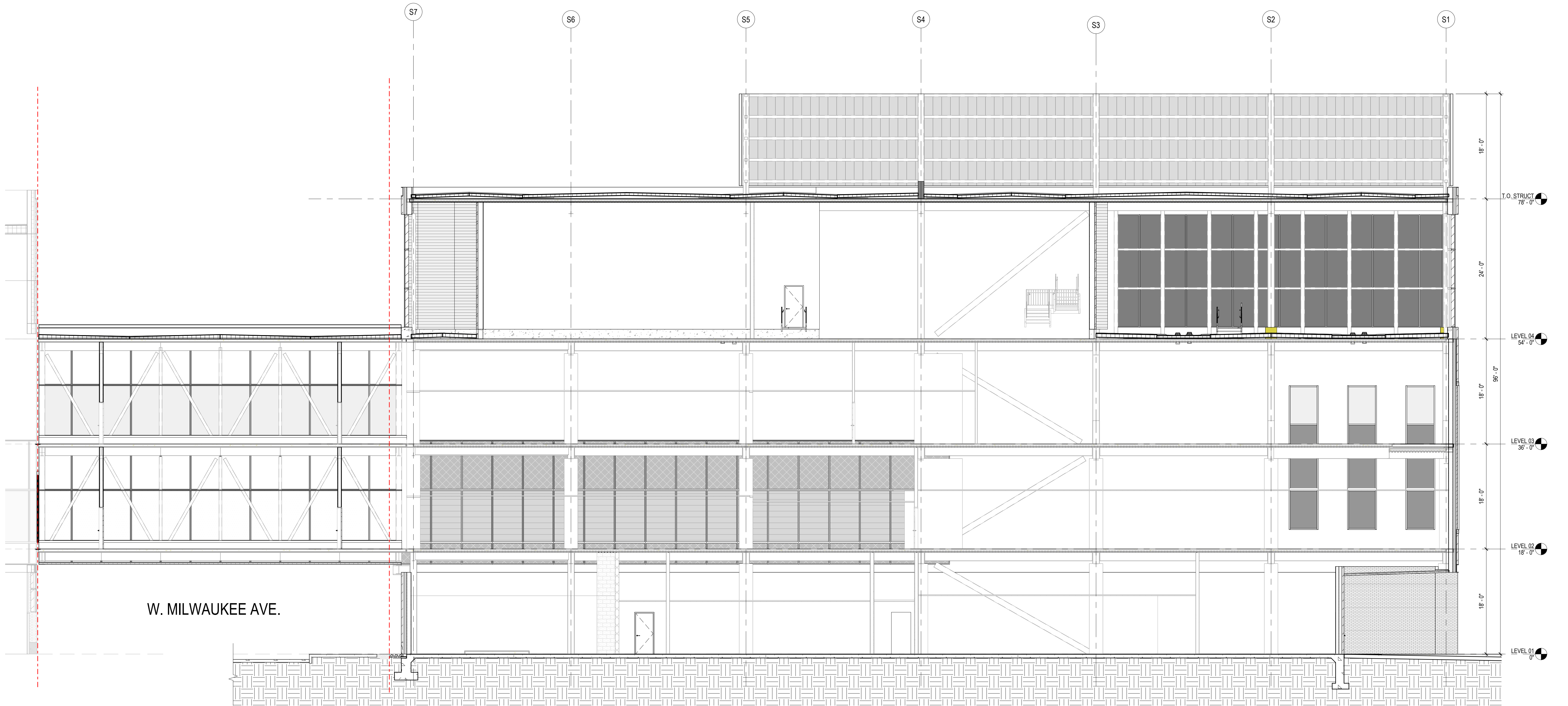

C5 BUILDING SECTION 2
1/8" = 1'-0"

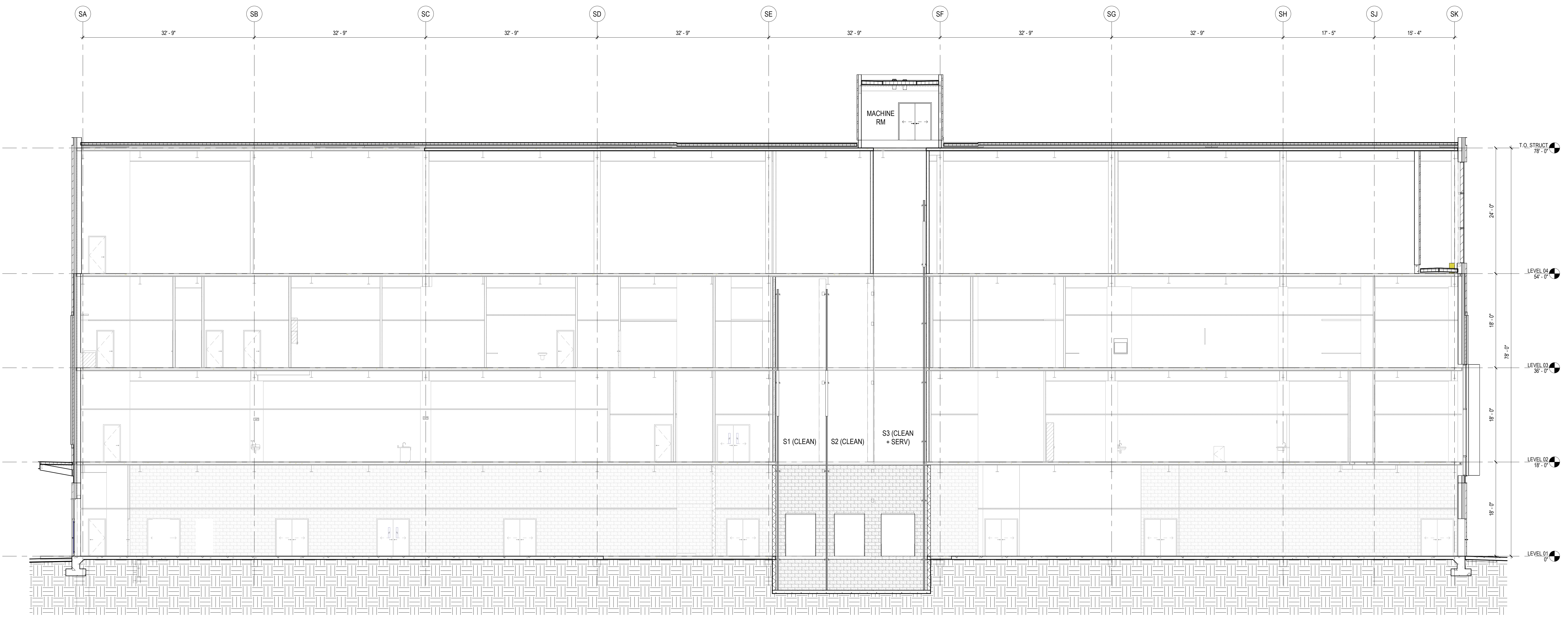

A5 BUILDING SECTION 1
1/8" = 1'-0"

EXTERIOR SYMBOLS	
BMV	EXTERIOR WALL ASSEMBLY TYPE CURTAINWALL SYSTEM TYPE
GW	GLAZING / SPANDREL PANEL TYPE
L	LOUVER TYPE
WT	EXTERIOR WINDOW ASSEMBLY, REFER TO A-800 SERIES

SHEET NOTES	
1.	REFER TO SHEET A-001 FOR SYMBOLS & GENERAL NOTES.
2.	REFER TO SHEETS A-500 & A-501 FOR EXTERIOR WALL AND ROOF TYPE ASSEMBLIES.
3.	EXTERIOR WALLS DIMENSIONS ARE TO FACE OF CURTAINWALL OR FACE OF MASONRY, UNO.

Destination: GRAND

HENRY FORD HEALTH

Henry Ford Hospital
Shared Services Building

West Grand Blvd.
Detroit, MI 48202

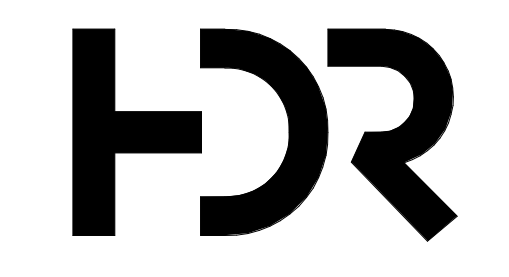

HamiltonAnderson



MARK	DATE	DESCRIPTION
	10/05/23	SSB SCHEMATIC DESIGN / EQ 1
	12/12/23	SSB EQ 2
	06/14/24	SSB DETAILED DESIGN

Project Number 10350997

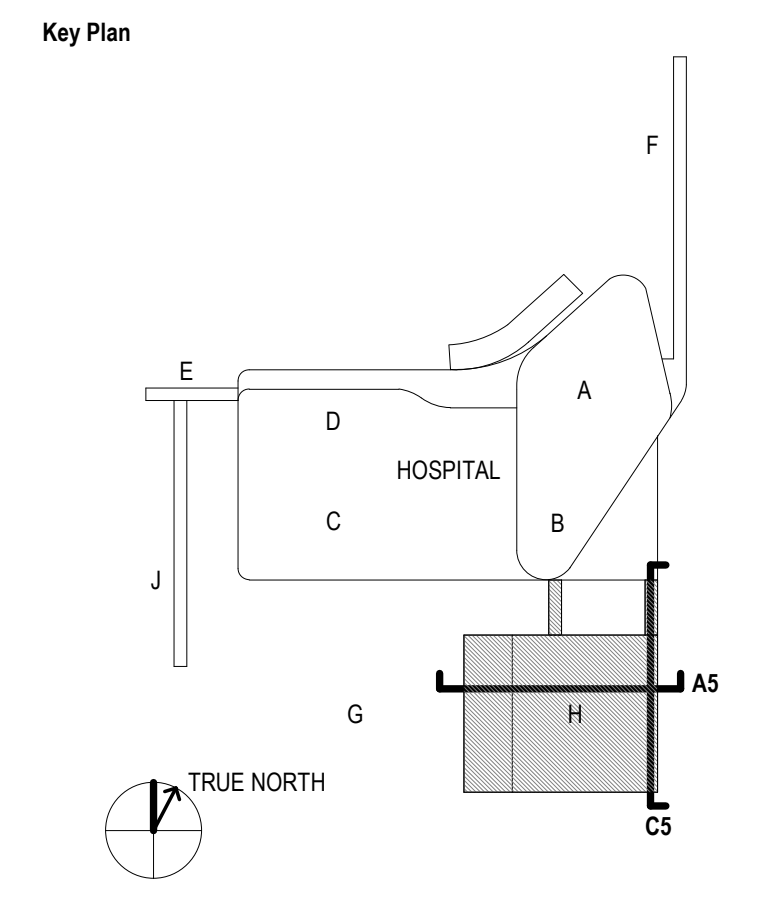

PRELIMINARY
NOT FOR CONSTRUCTION

Sheet Name
BUILDING SECTIONS

Scale
As indicated
Sheet Number

A.301

