

City of Detroit
OFFICE OF THE CITY CLERK

Janice M. Winfrey
City Clerk

Vivian A. Hudson
Deputy City Clerk

DEPARTMENTAL REFERENCE COMMUNICATION

Tuesday, December 13, 2016

To: The Department or Commission Listed Below

From: Janice M. Winfrey, Detroit City Clerk

The following petition is herewith referred to you for report and recommendation to the City Council.

In accordance with that body's directive, kindly return the same with your report in duplicate within four (4) weeks.

MAYOR'S OFFICE DPW - CITY ENGINEERING DIVISION
POLICE DEPARTMENT FIRE DEPARTMENT
BUILDINGS SAFETY ENGINEERING

1365 *Rock Ventures, LLC, request to host "Stereo Bot - Detroit" located in various locations in Downtown Detroit beginning on January 7, 2017 through February 19, 2017. Set up begins on 12/26/16 with tear down on 2/23/17.*

1365

City of Detroit Special Events Application

Successful events are the result of advance planning, effective communication and teamwork. You are required to complete the information below so that the City of Detroit can gain a thorough understanding of the scope and needs of the event. This form must be completed and returned to the City of Detroit Clerk's Office. There is a 90 day review process. At the end of the 90 days, the petition could either be approved or denied by departments. Please take into consideration the amount of time it will take to plan the event when submitting the application. If submitted later than 90 days prior, application is subject to denial. Please type or print clearly and attach additional sheets or maps as needed.

Section 1- GENERAL EVENT INFORMATION

Event Name: TBD

Stereobot - Detroit

Event Location: Downtown - Grand Circus Park, Capitol Park, Gratiot/Randolph Plaza, The Hudson's Site, Cobo Plaza & Woodward Ave.

Section 2- ORGANIZATION/APPLICANT INFORMATION

Organization Name: Rock Ventures, LLC

Organization Mailing Address: 1074 Woodward Ave., Detroit, MI 48226

Business Phone: (313) 373-1279

Business Fax: (877) 791-9468

Federal Tax ID # n/a

If registered as a non-profit, indicate non-profit ID number and attach a copy of the certificate.

Applicant Name: John Marcicky

Title/Role: Director of Placemaking and Public Space Activation

Email Address: JohnMarcicky@Rock Ventures.com

Mailing Address: 1074 Woodward Ave., Detroit, MI 48226

Business Phone: (313) 373-1279

Business Fax: (877) 791-9468

Event On-Site Contact Person:

Mailing Address: 1074 Woodward Ave., Detroit, MI 48226

Business Phone: (313) 373-1279

Business Fax: (877) 791-9468

List name/phone number of person(s) authorized to make decisions for the organization/event (indicate role/responsibility).

List Event Sponsors:

Rock Ventures, LLC & Stereobot & Downtown Detroit Partnership

Event Elements (check all that apply)

- | | | |
|--|--|--|
| <input type="checkbox"/> Walkathon | <input type="checkbox"/> Carnival/Circus | <input type="checkbox"/> Concert/Performance |
| <input type="checkbox"/> Run/Marathon | <input type="checkbox"/> Bike Race | <input type="checkbox"/> Religious Ceremony |
| <input type="checkbox"/> Political Event | <input type="checkbox"/> Festival | <input type="checkbox"/> Filming |
| <input type="checkbox"/> Parade | <input type="checkbox"/> Sports/Recreation | <input type="checkbox"/> Rally/Demonstration |
| <input type="checkbox"/> Convention/Conference | <input type="checkbox"/> Fireworks | <input checked="" type="checkbox"/> Other: Art Installations |

What are the projected set-up, event and tear down dates and times (must be completed)?

Begin Set-up Date & Time: Dec. 26, 2016 Complete Set-up Date & Time: Jan. 6, 2017

Event Start Date & Time: Jan. 7, 2017 Event End Date & Time: Feb. 19, 2017

Begin Tearing Down Date: Feb. 20, 2017 Complete Tear Down Date: Feb. 23, 2017

Event Times (If more than one day, give times for each day):

Is this the first time you have held this event in the City of Detroit? Yes No

If no, what years has the event been held in Detroit? n/a

When was the event last held in Detroit? n/a

Where was the event last held in Detroit? n/a

What were the hours last year? n/a

Project Attendance This Year (Minimum – Maximum)? _____

What is the basis for your projected attendance? _____

Please describe your anticipated/ target audience:

Is this going to be an annual event? Yes No

If yes, do you have a preferred/proposed for next year? TBD

If a parade is planned. Indicate elements (check all that apply):

People

Balloons

Floats

Animals

Vehicles

Other: N/A

Bands

If animals included, specify type, number and how used. N/A

Name of business supplying animal(s): _____

Contact Person: _____

Address: _____

Phone: _____

City/State/Zip: _____

Section 3- LOCATION/SITE INFORMATION

Location of Event: **Central Business District, Downtown (see attached map for locations)**

Facilities to be used (circle): Street Sidewalk Park City Facility

Please attach a site plan which illustrates the anticipated layout of your event including the following:

- Public entrance and exit
- Location of merchandising booths
- Location of food booths
- Location of garbage receptacles
- Location of beverage booths
- Location of sound stages
- Location of hand washing sinks
- Location of portable restrooms
- Location of First Aid
- Location of fire lane
- Proposed route for walk/run
- Location of tents and canopies
- Sketch of street closure
- Location of bleachers
- Location of press area
- Sketch of proposed light pole banners

Section 4- ENTERTAINMENT

What type of entertainment will be used? (check all that apply)

- Singers
- Musicians
- Comedians
- Magician
- Story Telling
- Other: See below.

Describe the entertainment for this year's event:

Each installation is a piece of illuminated art. Providing an immersive experience for visitors.

List proposed entertainers and/or bands performing at the event:

N/A

Will a sound system be used? Yes No

If yes, what type of sound system?

N/A

- Acoustic-audible, sound heard within natural range
- Amplified-augmented, sound increased to broaden range

The amplified sound will be used:

Will the event consist of a musical concert? Yes No

If yes, what type of music? (check all that apply)

- Live
- Recorded
- Karaoke/Lip-synch

Describe specific power needs for entertainment and/or music:

TBD

How many generators will be used? TBD

How will the generators be fueled?

TBD

Name of vendor providing generators:

Contact Person: TBD

Address:

Phone:

City/State/Zip: _____

Section 5- COMMUNICATION/ADVERTISING STRATEGY

Check all applicable boxes that describe the type of promotion you plan to use to attract participants:

- Radio (Specify stations):
- Television (Specific stations):
- Newspapers (specify papers):
- Web site (identify web address):
- Public Relations or Marketing Firm (Specify):

Contact Info:

- Raffle (List Item(s)):
- Billboards
- Flyers
- Street Banners
- Other (specify): _____

NOTE: All raffles subject to laws of State/City.

Section 6- SALES INFORMATION

Will there be advanced ticket sales? Yes No

If yes, please describe: _____

Will there be on-site ticket sales? Yes No

If yes, list price(s): _____

Will food be sold? Yes No

If yes, please pick up Special Events Vendor Packet in Suite 105: _____

Will merchandise be sold? Yes No

If yes, describe: _____

Will a percentage of the proceeds be distributed to a charitable organization? Yes No

If yes, describe: _____

If the event is a fundraiser, identify charity or recipient of funds:

n/a

Will there be vending or sales? Yes No
If yes, check all that apply:

- Food
- Merchandise
- Non-Alcoholic Beverages
- Alcoholic Beverages
- Other (specify): _____

Indicate type of items to be sold: _____

Will these be exclusive vendors or outside vendors? (please describe):

N/A

Section 7- PUBLIC SAFETY & PARKING INFORMATION

Name of Private Security Company: Rock Security Services

Contact Person: Marc Everett, Director of Security Services - Rock Ventures, LLC.

Address: 1074 Woodward Ave.

Phone: (313) 782-7208

City/State/Zip: Detroit, MI 48226

Number of Private Security Personnel Hired Per Shift: TBD by Marc Everett

Are the private security personnel (check all that apply):



Licensed



Armed



Bonded

Describe the emergency evacuation plan: TBD by Marc Everett

Describe the parking plan to accommodate anticipated attendance: surrounding parking garages and street parking

How will you advise attendees of parking options? N/A

Are you seeking a group parking rate? NO

Section 8- COMMUNITY IMPACT INFORMATION

How will your event impact the surrounding community (i.e. pedestrian traffic, sound carryover, safety)?

There will be increased pedestrian traffic, however not enough to disrupt normal business.

Have local neighborhood groups/businesses approved your event?



Yes



No

Indicate what steps you have or will take to notify them of your event: We're working with Bedrock, DDP, COBO and NAIAS We're working with Bedrock, DDP, COBO and NAIAS

to ensure a comprehensive communications plan is created. Emails, flyers and connecting with property owners are all tactics that have been used.

Indicate contact names and phone numbers (for verification) or attach approved letter(s):

Veronica Rickett | Bedrock | VeronicaRickett@bedrockdetroit.com | (313) 670-7482

Heather Badrak | D300 | hbadrak@detroit300.org | (313) 715-9944

Marc Everett | Rock Ventures | MarcEverett@quickenloans.com | (313) 407-5046

Thomas Taylor | DDP | thomas.taylor@downtowndetroit.org | (313) 418-6022

Section 9- EVENT SET-UP

Complete the appropriate categories that apply to the event.

Structure	Structure	Size L-W-H	Quantity	Weight
How Many? <u>16</u>	180 Beacon	12x3x12	10	150
Size/Height <u>see chart</u>	360 Beacon	18x18x18	2	350
Booth <u>n/a</u>	Hallo	50x50x15	1	500
Tent (enclosed on 3 sides) <u>n/a</u>	Arcade	25x50x15	1	500
Canopy (open on all sides) <u>n/a</u>	LightWeaver	70x70x35	1	2000
Staging/Scaffolding <u>n/a</u>	Gateway	70x30x35	1	2000
	Total	16		

Bleachers

N/A _____

Company:

Grill

Gas

Charcoal

Electrical

Propane

Fireworks (Pyrotechnics)

Aerial

Stage

Provide Sketch:

Portable Restrooms:

Standard

ADA Accessible

Vehicles

Type/Weight:

Other:

NOTE: Specific requirements must be met and special approval must be received by the Detroit Fire Department.

Will additional electrical wiring need to be installed? Specify locations, voltage, amperage, and phase.

TBD by Bedrock, DDP and Stereobot

Will additional utility services be used (power, water, etc.)? Please describe.

TBD by Bedrock, DDP and Stereobot

Do you plan a fireworks display? List dates, time, location, vendor, and attach certificate of insurance.

NO.

Section 10- COMPLETE ALL THAT APPLY

Name of Sanitation Company collecting refuse and garbage?

Contact Person: Clean Detroit, Ryan Epstein

Address: 1 Campus Martius #380

Phone: (313) 354-1276

City/State/Zip: Detroit, MI 48226

Name of company providing emergency medical services?

Contact Person: Rock Security Services, Marc Everett

Address: 1074 Woodward Ave.

City/State/Zip: Detroit, MI 48226

Name of company providing porta-johns. N/A

Contact Person: _____

Address: _____

Phone: _____

City/State/Zip: _____

Name of private catering company? N/A

Contact Person: _____

Address: _____

Phone: _____

City/State/Zip: _____

SPECIAL USE REQUESTS

List any streets or possible streets you are requesting to be closed. Include the day, date, and time of requested closing and reopening. Neighborhood Signatures must be submitted with application for approval.

Attach a map or sketch of the proposed area for closure.

STREET NAME: the streets will be closed. _____

FROM _____
TO _____

Closure Dates: _____
Beg. Time: _____
End Time: _____
Reopen Date: _____
Time: _____

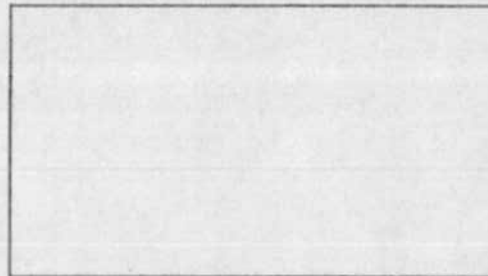

STREET NAME: _____

FROM _____
TO _____

Closure Dates: _____
Beg. Time: _____
End Time: _____
Reopen Date: _____
Time: _____

STREET NAME: _____

FROM _____
TO _____

Closure Dates: _____
Beg. Time: _____
End Time: _____
Reopen Date: _____
Time: _____

STREET NAME: _____

FROM _____
TO _____

Closure Dates: _____
Beg. Time: _____
End Time: _____
Reopen Date: _____
Time: _____

Requested City Equipment

Provided In: n/a (year)

Current Request: n/a (year)

Street Closures: n/a

Posting no parking signs

Light pole

Electrical Services

Storage for Trailers/Trunks

Barricades are not available from the City of Detroit.

ADDITIONAL INFORMATION

Is there any additional information that you feel is important to mention regarding your event or additional requests?

See print outs.

AUTHORIZATION & AFFIDAVIT OF APPLICANT

I certify that the information contained in the foregoing application is true and correct to the best of my knowledge and belief that I have read, understand and agree to abide by the rules and regulations governing the proposed Special Event, and I understand that this application is made subject to the rules and regulation established by the Mayor or the Mayor's designee. Applicant agrees to comply with all other requirements of the City, County, State, and Federal Government and any other applicable entity, which may pertain to Special Events. I further agree to abide by these rules, and further certify that I, on behalf of the Event agree to be financially responsible for any costs and fees that may be incurred by or on behalf of the Event, to the City of Detroit.

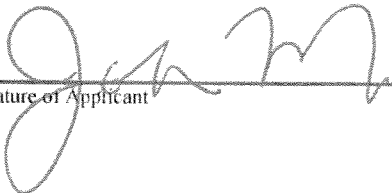
Signature of Applicant  Date 11/28/16

NOTE: Completion of this form does not constitute approval of your event. Pending review by the Special Events Management Team, you will be notified of any requirements, fees, and/or restrictions pertaining to your event.

SPECIAL EVENTS CONTACT LIST

Department/Agency	Contact Person	Email Address	Phone Number
Building & Safety Department			(313)224-3259
Business License Department	Yakeima Fife	fifeya@detroitmi.gov	(313)224-0365
Campus Martius Park	Heather Badrak		(313) 962-0112
Clean Detroit	Ryan Epstein		(313) 354-1276
Coleman A. Young International Airport	Tyra Williams		(313) 833-7666
Detroit Police Department – Tactical Operations – Large Special Events and Parades in Downtown Area.	Sgt. Janae Stinson	Stinsonj251@detroitmi.gov	(313)237-2828
Detroit Police Department – Liquor License Division – 24 Hour Temporary Liquor License			(313) 596-1954
Detroit Fire Department	Capt. Eric Davis	daviser@detroitmi.gov	(313)596-2932
Detroit People Mover	Ericka Alexander	ealexander@thepeoplemover.com	(313)224-2148
Detroit Public Works – Right of Way Fees	Leslie Lord	lordl@cadtwr.ci.detroit.mi.us	(313)224-3935
Detroit Riverfront Conservancy			(313)566-8200
Eastern Market			(313)833.9300
Health & Wellness Department – Food License and Permits	Denise Talley-Ndiaye	talleyd@detroitmi.gov	(313)870-2729
Municipal Parking Department – Parking Meters Rentals	Linda Harris	harrisli@detroitmi.gov	(313)221-2520
Municipal Parking Department – Parking Lots/Garages	Angela Nash	nasha@detroitmi.gov	(313)221-2527
Mayor's Office – Film, Culture and Special Events	Sommer Woods	woodss@detroitmi.gov	(313)224-1606
Recreation Department – Belle Isle Park	Tracy Lawrence	lawrenct@detroitmi.gov	(313) 628-2081
Recreation Department – Fort Wayne		fortwayneinfo@detroitmi.gov	(313) 628-0796
Recreation Department – Hart Plaza	Howard Nash	hnash@detroitmi.gov	313-877-8074
Recreation Department – (Excludes Hart Plaza, Belle Isle and Fort Wayne)	Lynn Shaw	lshaw@detroitmi.gov	(313) 877-8075

**2011 CITY OF DETROIT SPECIAL EVENTS
FEE SCHEDULE**

(Fees are subject to change without notice)

Department	Service Description	Fee
Business License	Business License Permit – Any goods that will be sold on the public right of way must obtain a permit per vendor. This includes dry goods, merchandise, food or beverage.	\$115 per point of sale. Late applications will be assessed late fees. Fee is waived is vendor is distributing materials complimentary. Example of fee waivers: Organizations passing out literature.
Building & Safety Engineering	Permit for Temporary Signage, electrical/generator, bleachers and tents larger than 10x10.	Fees Vary
Detroit Fire Department	Tent Inspection (not per tent) – tents less than or equal to 10x10.	\$111 / first hour / \$56 each add'l hr
Detroit Fire Department	Tent Inspection (not per tent) – larger than or equal to 10x10.	\$186 / first hour / \$56 each add'l hr
Detroit Fire Department	Fire Hydrant Deposit	\$210
Detroit Fire Department	Fire Hydrant Permit – 10 day minimum	\$75 / day
Detroit Police Department	Police Officer – (Four (4) Minimum per officer) Min. Detail is Three (3) Officers and One (1) Supervisor	\$38.38 / hr
Detroit Police Department	Supervisor – Four (4) hour minimum	\$49.03 /hr
Detroit Police Department	NO – PARKING Signs	\$1.50 per sheet
Detroit Police Department – Liquor License Unit	24 Hour Liquor License applications must be obtained from the State of Michigan website.	
Detroit Public Works	Barricades	A security deposit may be applicable.
Detroit Recreation Department		Fees Vary, refer to website www.detroitmi.gov for additional information.
Detroit Public Works – City Engineering	Right of Way (ROW) Permit – ROW Fee is applicable if applicant is charging a fee to an event on a public right of way.	\$400 per eight (8) hours / \$1,200 for 24 hour permit
Health & Wellness Department	Temporary Food License	\$250 per point of sale (Non Profits can be considered for discount permit fee). Late applications will be assessed a late fee. Fee is waived if vendor is distributing food complimentary, but an application must be completed. Example of fee waiver: food bank
Municipal Parking Department	Meter – if a street closure includes parking meters, the meter must be reserved for the day.	\$20 per day

**2011 SPECIAL EFFECTS/PYROTECHNICS
DETROIT FIRE DEPARTMENT
FEE SCHEDULE**

(Fees are subject to change without notice)

Department	Service Description	Fee
Detroit Fire Department	Fireworks / Explosive Storage – 1 – 100 LBS	\$157 per day
Detroit Fire Department	Fireworks / Explosive Storage – 101-500 LBS	\$187 per day
Detroit Fire Department	Fireworks / Explosive Storage – 501 – 1,000 LBS	\$214 per day
Detroit Fire Department	Fireworks / Explosive Storage – 1,001 – 5,000 LBS	\$240 per day
Detroit Fire Department	Fireworks / Explosive Storage – 5,001 – 10,000 LBS	\$269 per day
Detroit Fire Department	Fireworks / Explosive Storage – OVER 10,000 LBS	\$297 per day
Detroit Fire Department	Fireworks/Pyrotechnics – Escort /Transport Explos Insp & Permit (RENEW)	\$223
Detroit Fire Department	Fireworks/Pyrotechnics – Escort /Transport Explos Insp & Permit (NEW)	\$445
Detroit Fire Department	Fireworks/Pyrotechnics -- Fireworks Transport Permit (1-100 lbs)	\$129
Detroit Fire Department	Fireworks/Pyrotechnics – Fireworks Transport Permit (Over 100 lbs)	\$240
Detroit Fire Department	Fireworks/Pyrotechnics – Fireworks Display Witness	\$241
Detroit Fire Department	Fireworks/Pyrotechnics – Field Inspection	\$111
Detroit Fire Department	Plan Review - FBHR	\$116 / hr
Detroit Fire Department	On-Site Inspection / Review	\$111 / hr
Detroit Fire Department	Certificate of Fitness – One (1) year	\$56
Detroit Fire Department	Certificate of Fitness – Three (3) year	\$69
Detroit Fire Department	Chief	\$130 / hr
Detroit Fire Department	Safety Officer	\$130 /hr
Detroit Fire Department	Engine	\$130/hr
Detroit Fire Department	Ladder Truck	\$130 / hr
Detroit Fire Department	Squad / T.M.S	\$130 / hr
Detroit Fire Department	E.M.S.	\$130 /hr
Detroit Fire Department	Duty Officer	\$130 / hr
Detroit Fire Department	Manufact/Wholesale Pkgs/Stor Flam Liquid <51 GALS	\$73
Detroit Fire Department	Manufact/Wholesale Pkgs/Stor Flam Liquid 51-100 GALS	\$130
Detroit Fire Department	Manufact/Wholesale Pkgs/Stor Flam Liquid 101 – 1,000 GALS	\$270
Detroit Fire Department	Manufact/Wholesale Pkgs/Stor Flam Liquid 1,001 – 5,000 GALS	\$325
Detroit Fire Department	Manufact/Wholesale Pkgs/Stor Flam Liquid 5,001 – 20,000 GALS	\$395
Detroit Fire Department	Manufact/Wholesale Pkgs/Stor Flam	\$506

	Liquid 20,001 – 100,000 GALS	
Detroit Fire Department	Manufact/Wholesale Pkgs/Stor Flam Liquid >100,001 GALS	\$1,093
Detroit Fire Department	Gas Storage – 3K-13k CU Ft	\$408
Detroit Fire Department	Gas Storage – 13,001-25K CU Ft	\$424
Detroit Fire Department	Gas Storage – Over 25K CU Ft	\$520
Detroit Fire Department	Gas Storage – Over 25K CU Ft	Detroit Fire Department
Detroit Fire Department	Gas Storage – One (1) Torch Unit	\$21
Detroit Fire Department	Gas Storage – Temp Instal of Flam Compressed Liquid Gas	\$111
Detroit Fire Department	Consultation	\$111 / first hour / \$56 each add'l
Detroit Fire Department	Miscellaneous Request	\$111 /hr

STEREOBOT

STEREO.BOT
1246 West 2nd Street,
Los Angeles, 90026 CA
P: +1 (323)350.6380
E: info@stereo-bot.com

INDEX

A0.0	INDEX
A2.1-a	TOP VIEW PLAN - GATEWAY
A3.0-a	ELEVATIONS - GATEWAY
A2.1-b	TOP VIEW PLAN - LIGHTWEAVER
A3.0-b	ELEVATIONS - LIGHTWEAVER
A2.1-c	TOP VIEW PLAN - HALLO
A3.0-c	ELEVATIONS - HALLO
A2.1-d	TOP VIEW PLAN - 360 BEACON
A3.0-d	ELEVATIONS - 360 BEACON
A6.1	TYPICAL FRAMING
A6.2	FRAMING DETAIL
A6.3	DETAILS
A6.4	DETAILS
A6.5	DETAILS
A7.1	FOUNDATION TYPES
A7.2	FOUNDATION TYPES
A7.3	FOUNDATION DETAILS
A7.4	FOUNDATION DETAILS
A7.5	FOUNDATION DETAILS

COVER SHEET /
INDEX

A0.0

STEREOBOT

STEREOBOT
1248 West 2nd Street,
Los Angeles 90026 CA
P +1 (323)350.6380
E info@stereo-bot.com

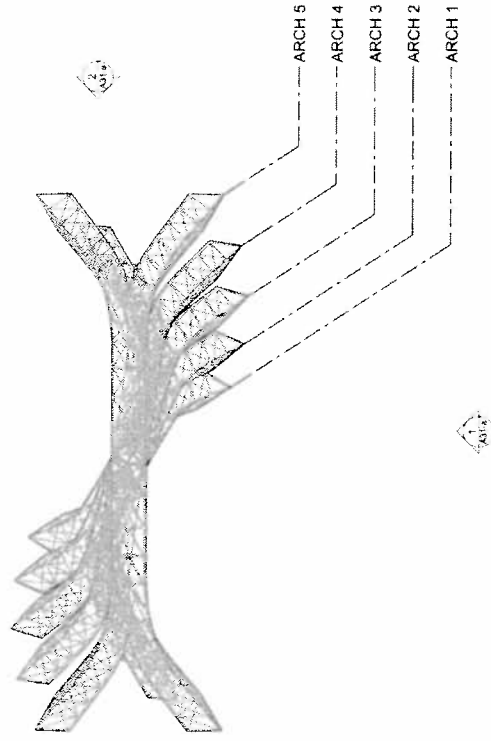

GATEWAY

QUANTITY: 1
SIZE: 70' X 30' X 35'
WEIGHT: 2,000 LBS

SCALE: 1/16" = 1'-0"

TOP VIEW PLAN

1 TOP VIEW PLAN

A2.0 -a

STEREOBOT

STEREO BOT
1246 West 2nd Street,
Los Angeles, 90026 CA
P: +1 (323)350 6380
E: info@stereo-bot.com

TOP OF ARCH 5 ± 35'-0"

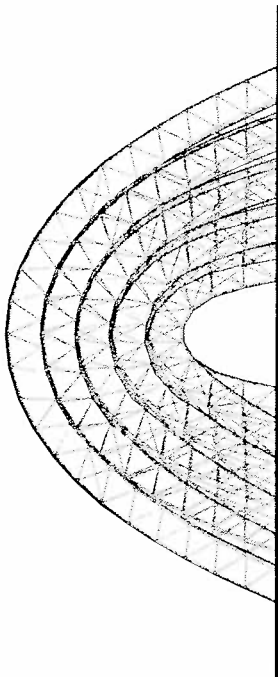

GROUND LEVEL 0'-0"

1 FRONT ELEVATION

TOP OF ARCH 5 ± 35'-0"

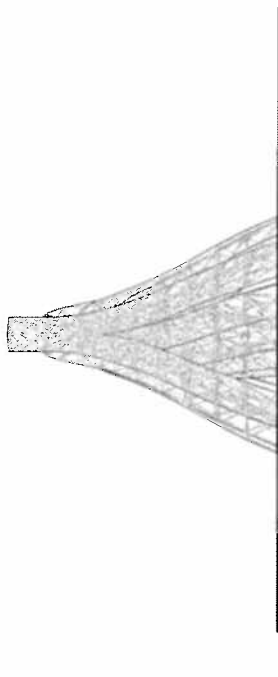

GROUND LEVEL 0'-0"

2 SIDE ELEVATION

GATEWAY

QUANTITY: 1
SIZE: 70' X 30' X 35'
WEIGHT: 2,000 LBS

SCALE: 1/16" = 1'-0"

ELEVATIONS

A3.0 - a

STEREOBOT

STEREO.BOT
1246 West 2nd Street,
Los Angeles, 90026 CA
P: +1 (323)350.6380
E: info@stereobot.com

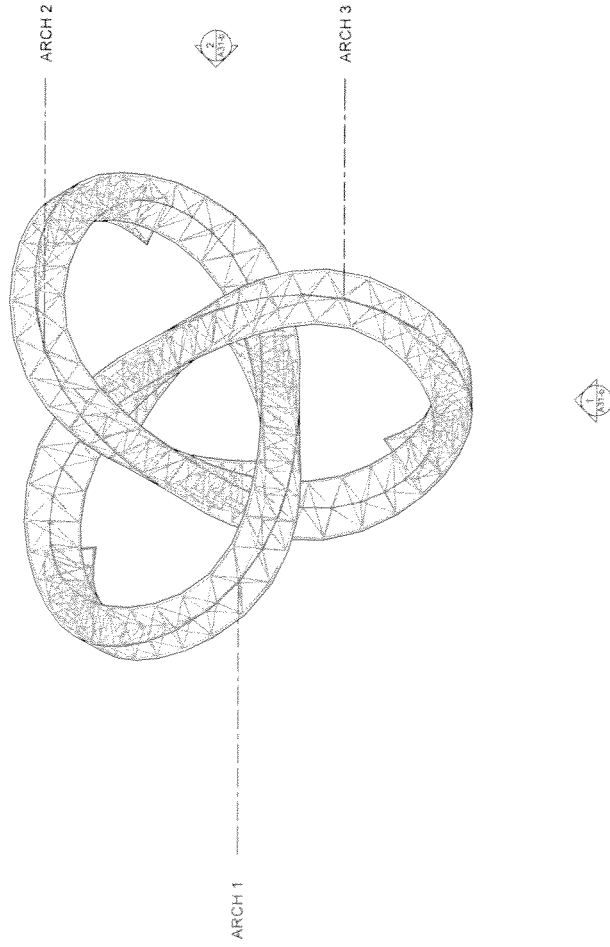

LIGHTWEAVER

QUANTITY: 1
SIZE: 70" X 70" X 35"
WEIGHT: 2,000 LBS

SCALE: 1/16" = 1'-0"

TOP VIEW PLAN

1 TOP VIEW PLAN

A2.0 -b

STEREOBOT

STEREO.BOT
1246 West 2nd Street,
Los Angeles, 90026 CA
P: +1 (323)350.6380
E: info@stereo-bot.com

ARCH 1 ARCH 2 ARCH 3

TOP OF ARCH 1,2,3 ± 35'-0"

GROUND LEVEL 0'-0"

1 FRONT ELEVATION

TOP OF ARCH 1,2,3 ± 35'-0"

GROUND LEVEL 0'-0"

2 SIDE ELEVATION

LIGHTWEAVER

QUANTITY: 1
SIZE: 70" X 70" X 35"
WEIGHT: 2,000 LBS

SCALE: 1/16" = 1'-0"

ELEVATIONS

A3.0 - b

STEREOBOT

STEREO.BOT
1246 West 2nd Street,
Los Angeles, 90026 CA
P: +1 (323)350.6380
E: info@stereo-bot.com

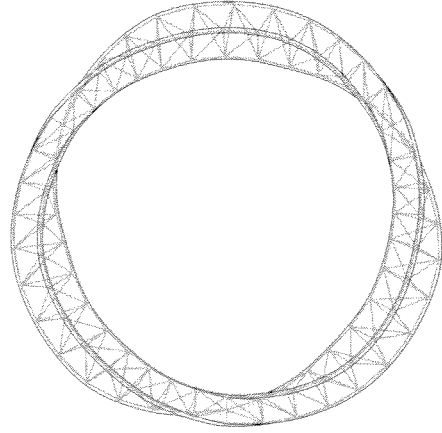

HALLO

QUANTITY: 1
SIZE: 50" X 50" X 15"
WEIGHT: 500 LBS

SCALE: 1/16" = 1'-0"

TOP VIEW PLAN

1 TOP VIEW PLAN

A2.0 -c

STEREOBOT

STEREO.BOT
1246 West 2nd Street,
Los Angeles, 90026 CA
P: +1 (323) 550.6380
E: info@stereo-bot.com

TOP OF STRUCTURE ± 15'-0"

GROUND LEVEL 0'-0"



1

FRONT ELEVATION

TOP OF STRUCTURE ± 15'-0"

GROUND LEVEL 0'-0"



2

SIDE ELEVATION

HALLO

QUANTITY: 1
SIZE: 50" X 60" X 15"
WEIGHT: 500 LBS

SCALE: 1/16" = 1'-0"

ELEVATIONS

A3.0 - c

STEREOBOT

STEREO.BOT
1246 West 2nd Street,
Los Angeles, 90026 CA
P: +1 (323)350.6380
E: info@stereo-bot.com

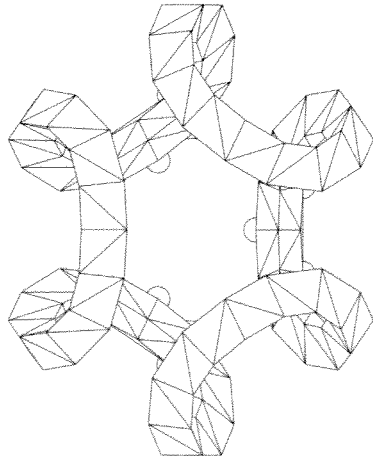

360 BEACON

QUANTITY: 2
SIZE: 18" X 18" X 18"
WEIGHT: 350 LBS

SCALE: 1/8" = 1'-0"

TOP VIEW PLAN

1 TOP VIEW PLAN

A2.0 -d

STEREOBOT

STEREO.BOT
1246 West 2nd Street,
Los Angeles, 90026 CA
P: +1 (323)350.6380
E: info@stereo-bot.com

TOP OF STRUCTURE ± 18'-0"

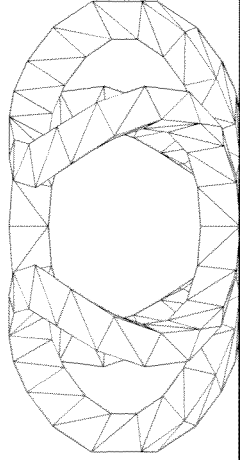

GROUND LEVEL 0'-0"

1 FRONT ELEVATION

TOP OF STRUCTURE ± 18'-0"

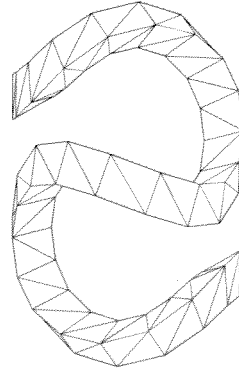

GROUND LEVEL 0'-0"

2 SIDE ELEVATION

360 BEACON

QUANTITY: 2
SIZE: 18' X 18' X 18'
WEIGHT: 350 LBS

SCALE: 1/8" = 1'-0"

ELEVATIONS

A3.0 - d

STEREOBOT

STEREO.BOT
 1246 West 2nd Street,
 Los Angeles, 90026 CA
 P: +1 (323)350.6380
 E: info@stereo-bot.com

1
A6.2

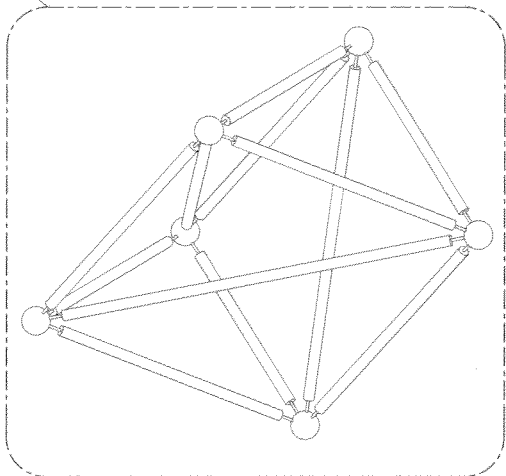

2.0
A7.3

2 MODEL - ISOMETRIC

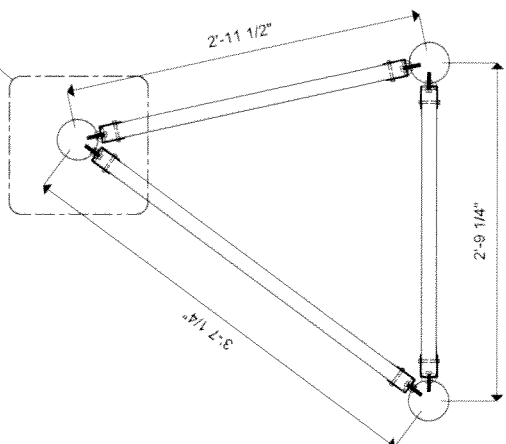

4 MODEL - SECTION

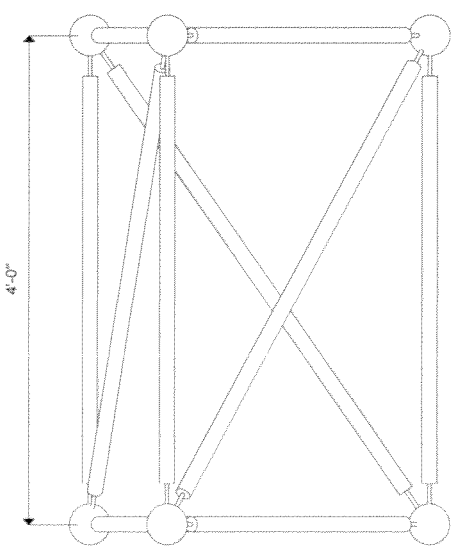

1 MODEL - TOP VIEW

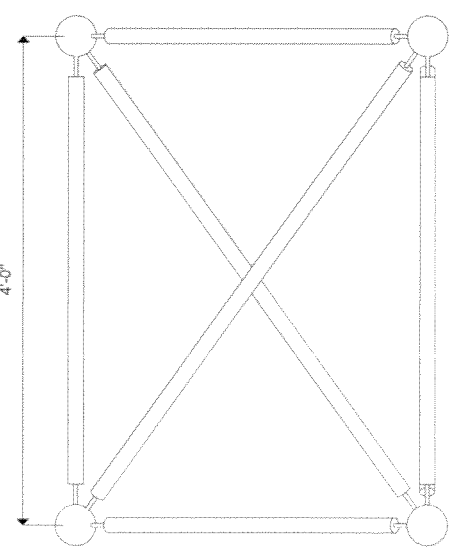

3 MODEL - FRONT VIEW

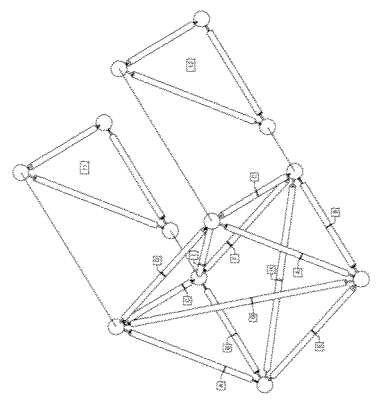

SCALE: 1" = 1'-0"

TYPICAL FRAMING

A6.1

STEREOBOT

STEREO.BOT
 1246 West 2nd Street,
 Los Angeles, 90026 CA
 P: +1 (323)350.6380
 E: info@stereo-bot.com

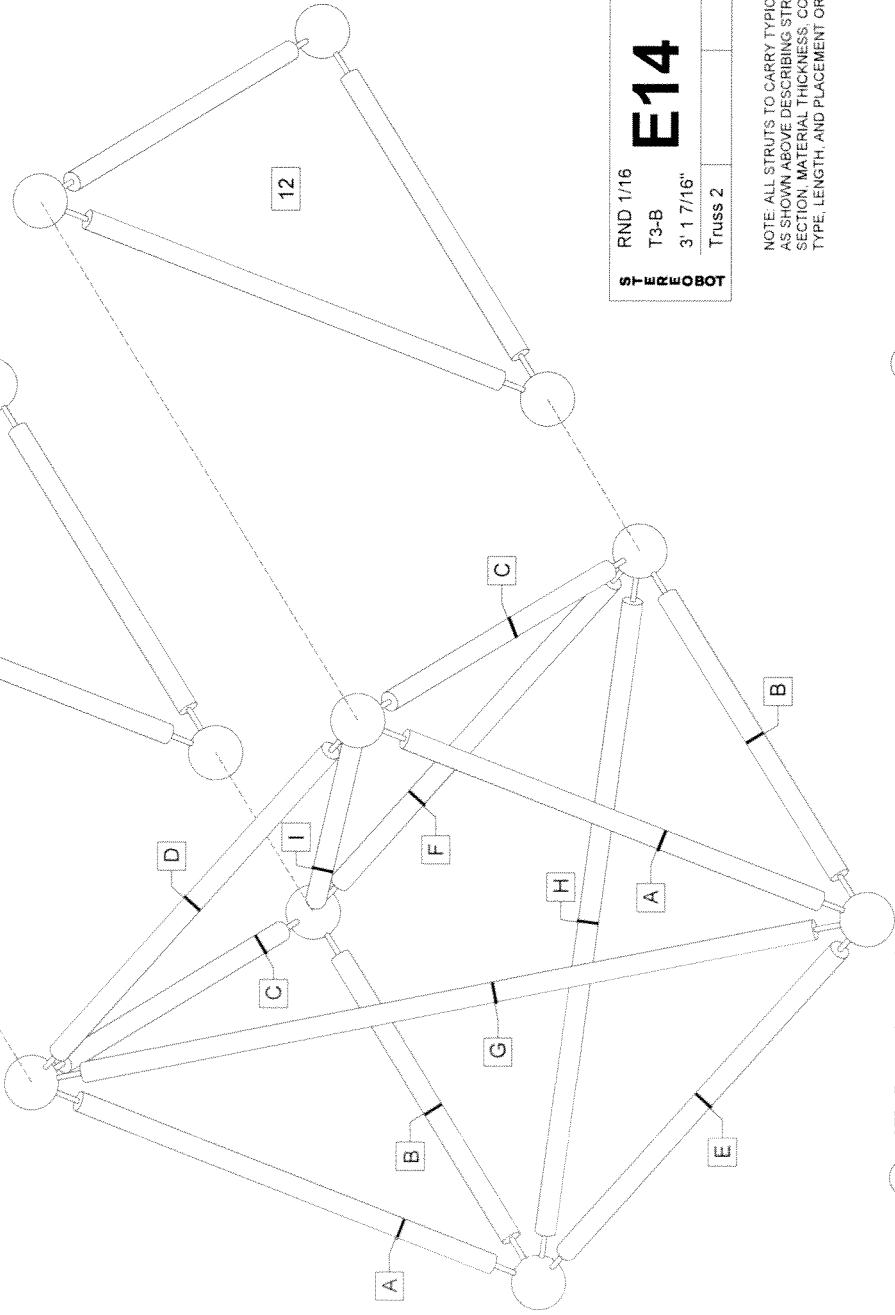

STEREOBOT	
RND 1/16	E14
T3-B	
3' 1 7/16"	
Truss 2	

NOTE: ALL STRUTS TO CARRY TYPICAL LABEL AS SHOWN ABOVE DESCRIBING STRUT SECTION, MATERIAL THICKNESS, CONNECTION TYPE, LENGTH, AND PLACEMENT ORDER.

1 STRUT NETWORK TYPICAL

2 STRUT LABEL TYPICAL

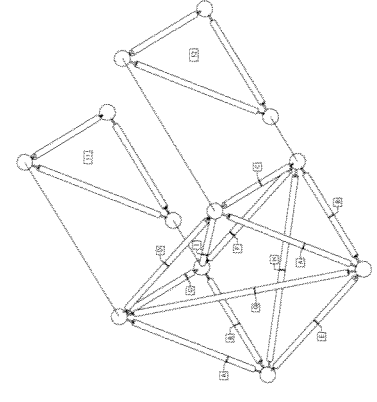

SCALE: 1" = 1'-0"

FRAMING DETAILS

A6.2

STEREOBOT

STEREO.BOT
1246 West 2nd Street,
Los Angeles, 90026 CA
P: +1 (323) 350.6380
E: info@stereo-bot.com

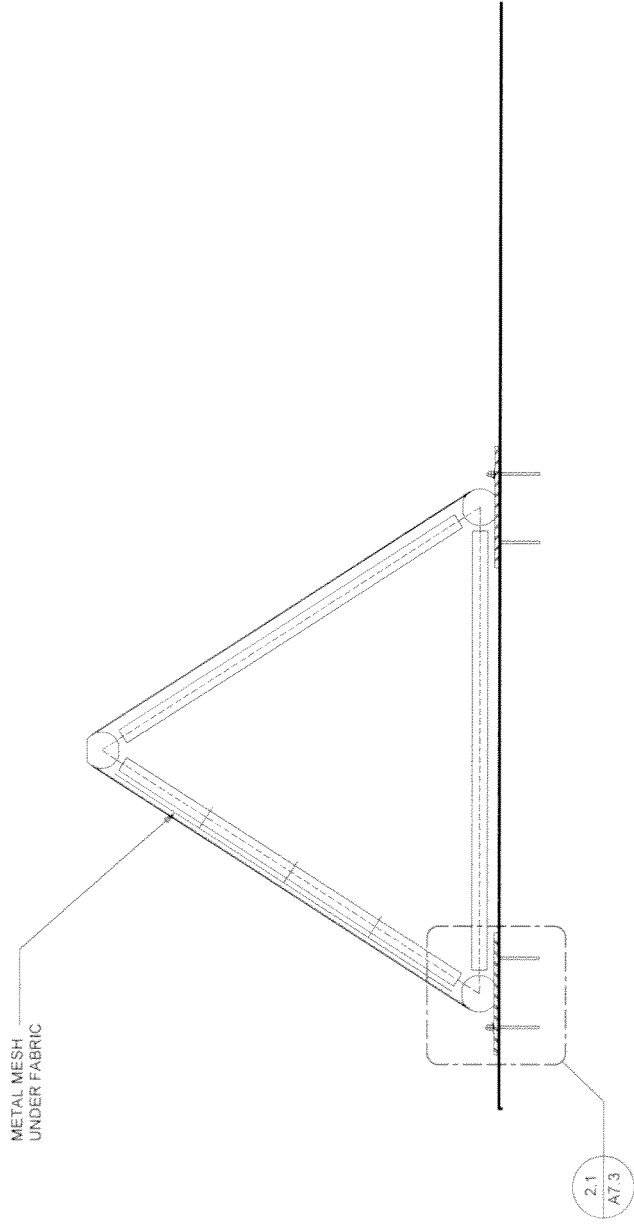

SCALE: 1" = 1'-0"

DETAILS

A6.3

STEREOBOT

STEREO.BOT
1246 West 2nd Street,
Los Angeles, 90026 CA
P: +1 (323)350.6380
E: info@stereo-bot.com

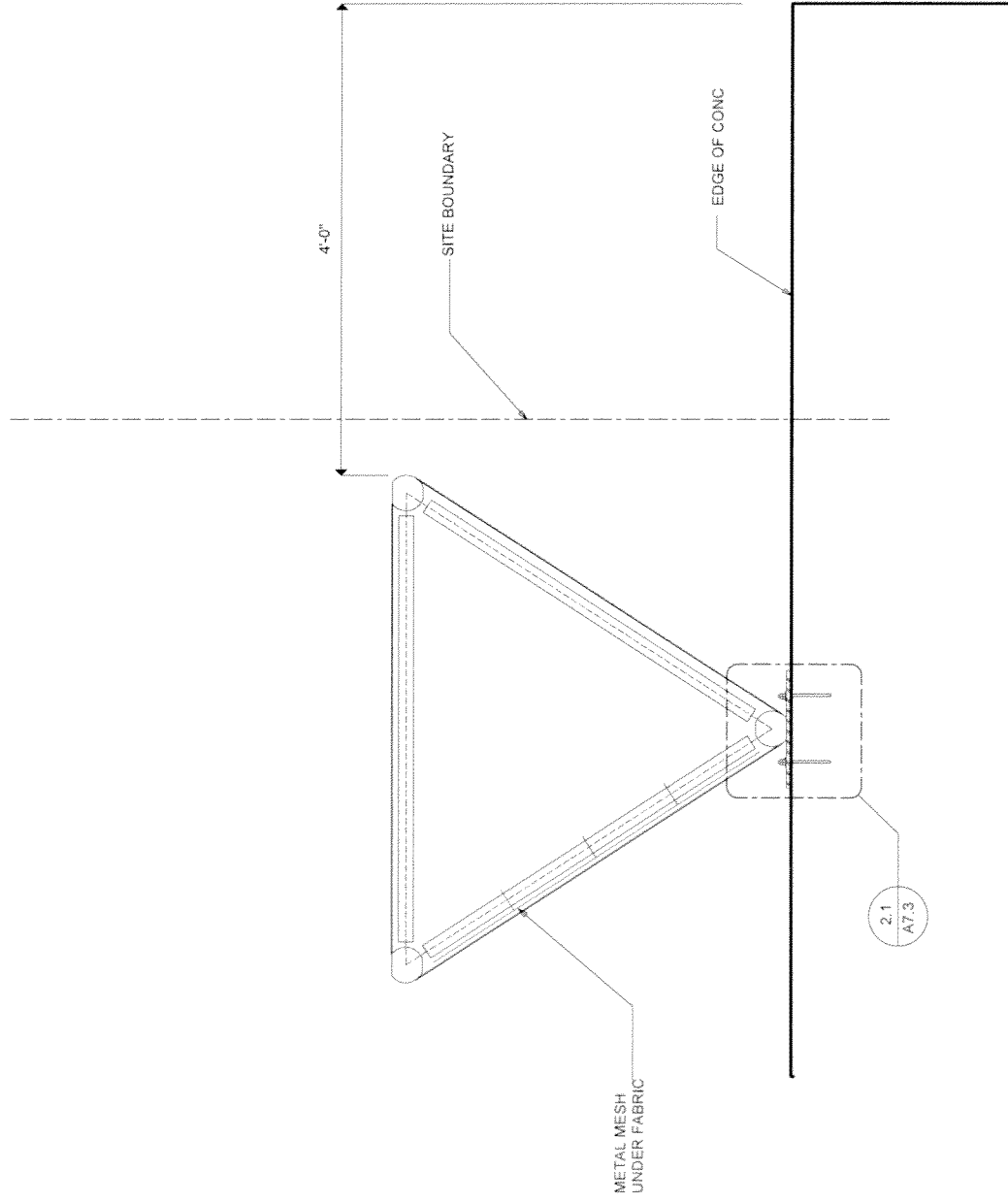

SCALE: 1" = 1'-0"

DETAILS

1 SECTION DETAIL

A6.4

STEREOBOT

STEREO.BOT
1246 West 2nd Street,
Los Angeles, 90026 CA
P: +1 (323)350.6380
E: info@stereo-bot.com

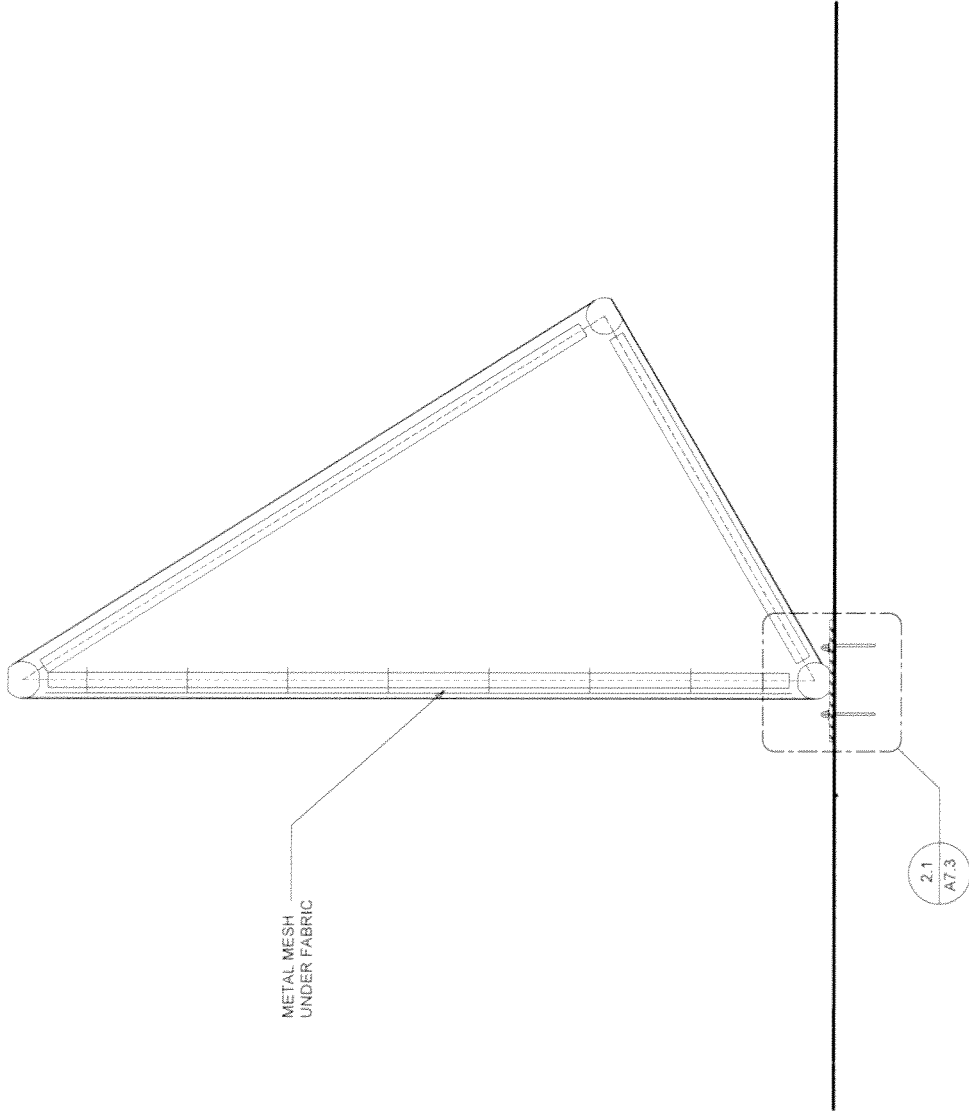

SCALE: 1" = 1'-0"

DETAILS

1 SECTION DETAIL

A6.5

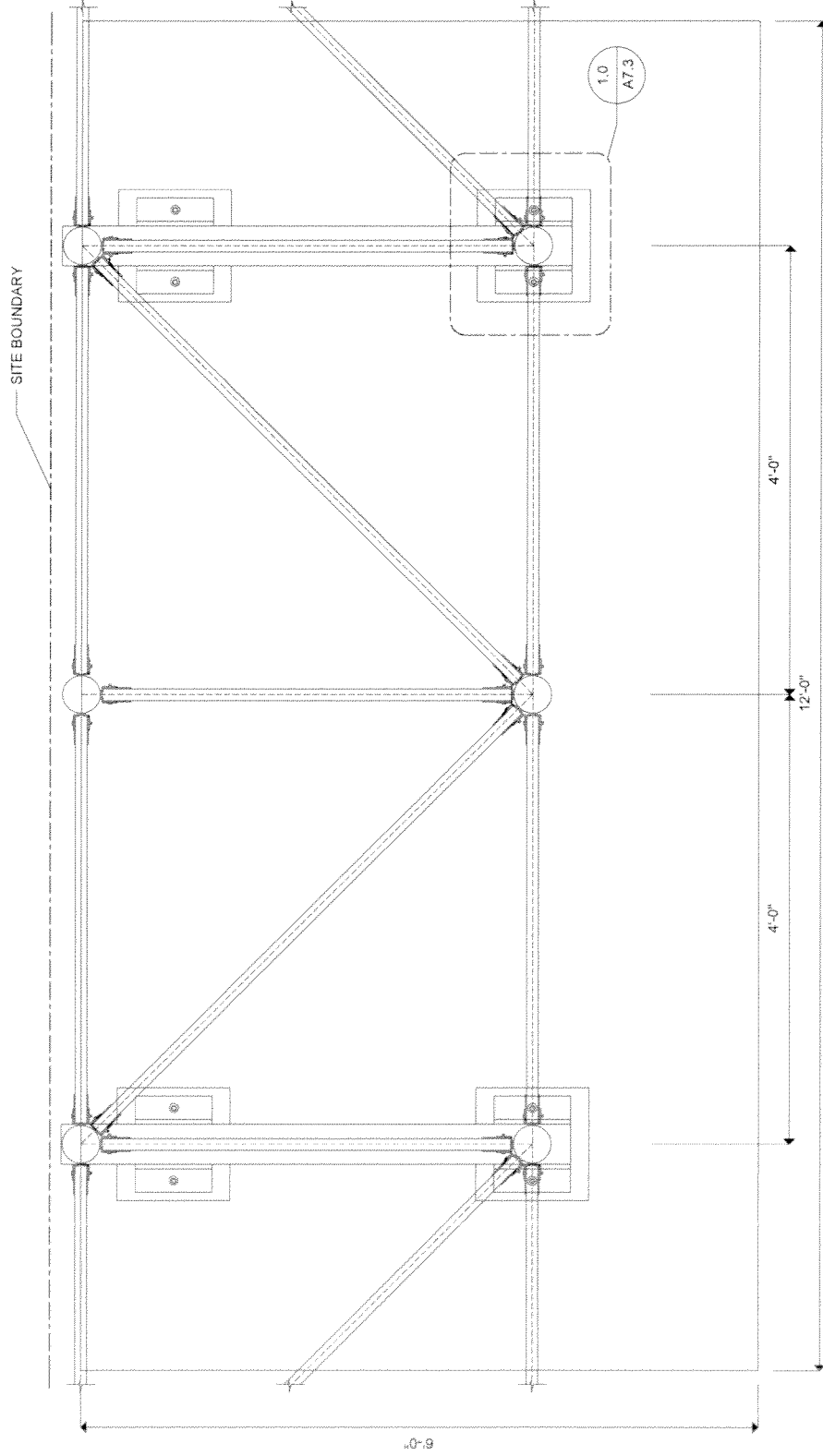

1.0 F1 FOUNDATION DETAIL

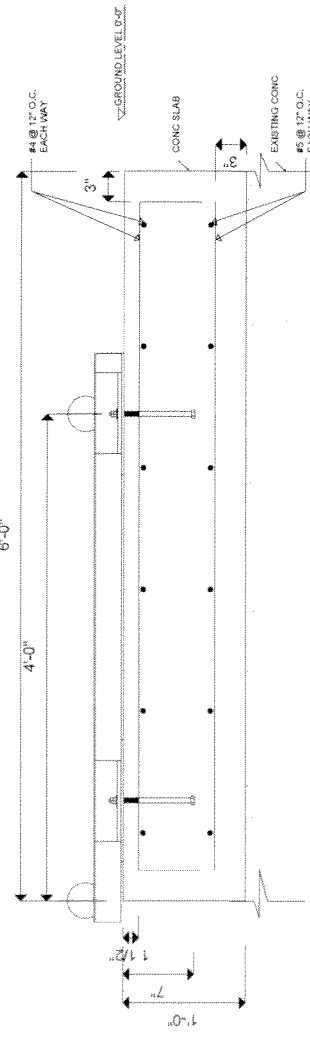

1.1 F1 FOUNDATION SECTION DETAIL

SCALE: 1" = 1'-0"

FOUNDATION TYPE F1

A7.1

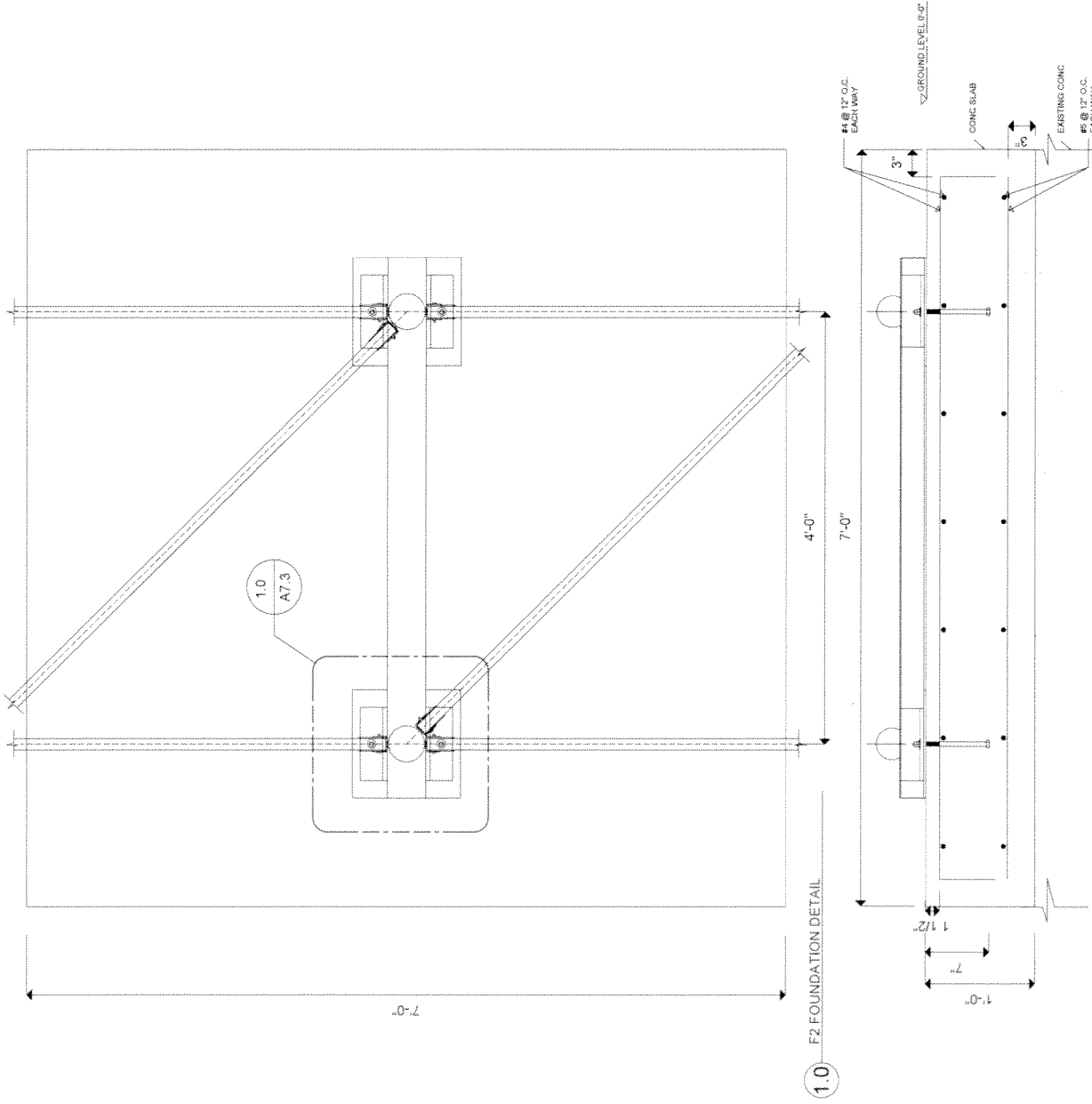

SCALE: 1" = 1'-0"

FOUNDATION TYPE F2

STEREOBOT

STEREO.BOT
 1246 West 2nd Street,
 Los Angeles, 90026 CA
 P. +1 (323)350 6380
 E. info@stereo-bot.com

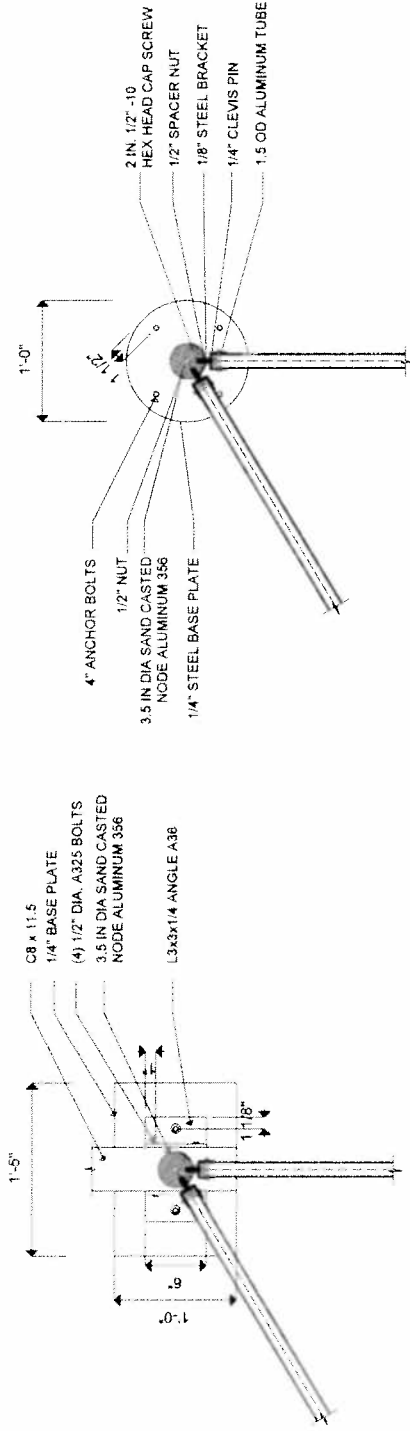

1.0 TYP. CONCRETE SLAB ANCHORING F1&F2
 PLAN

2.0 TYP. FOUNDATION F3
 PLAN

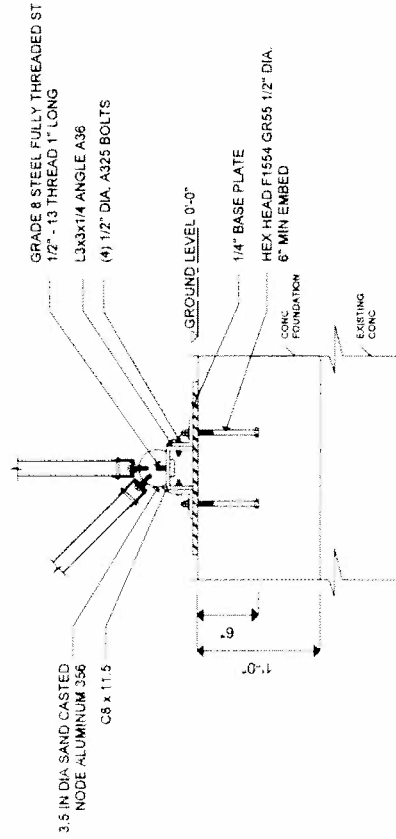

1.1 TYP. CONCRETE SLAB ANCHORING
 SECTION

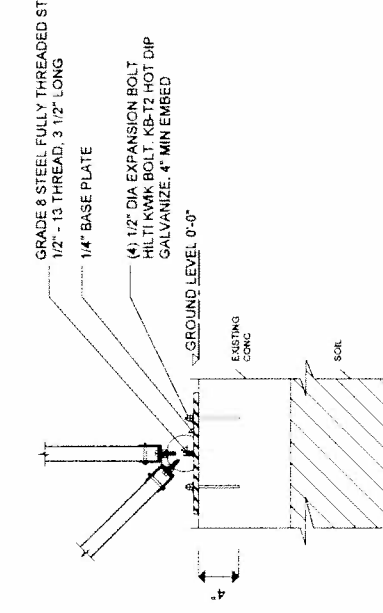

2.1 TYP. FOUNDATION SECTION F3
 SECTION

SCALE: 1" = 1'-0"

FOUNDATION DETAILS

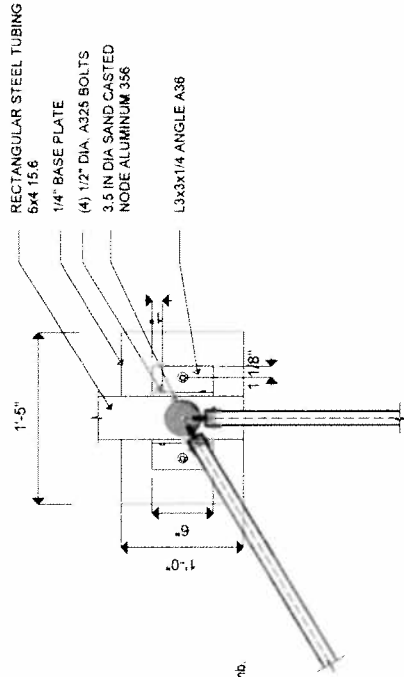

1.0 TYP CONCRETE SLAB ANCHORING F4
 PLAN

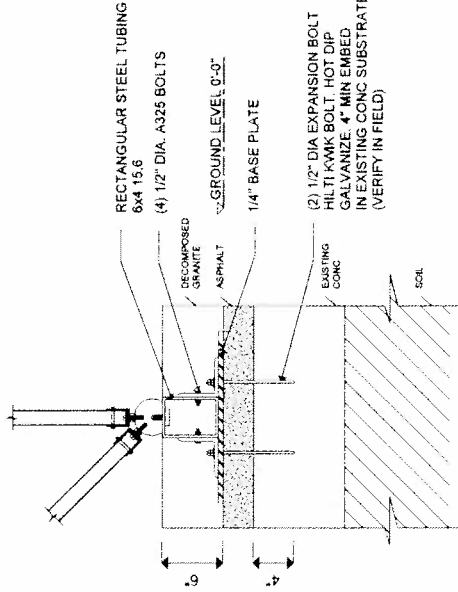

1.1 TYP CONCRETE SLAB ANCHORING F4
 SECTION

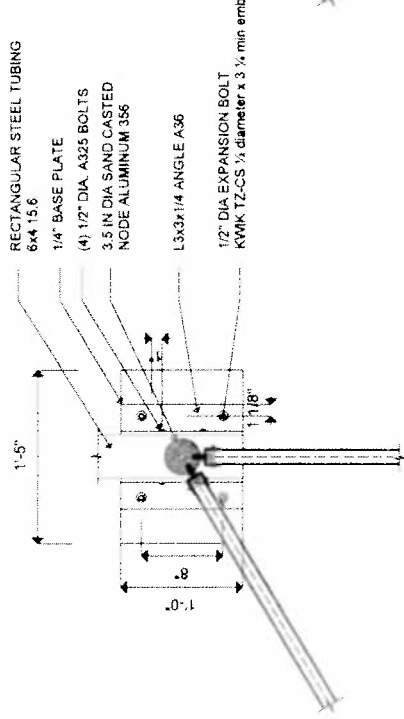

2.0 TYP CONCRETE SLAB ANCHORING F5
 PLAN

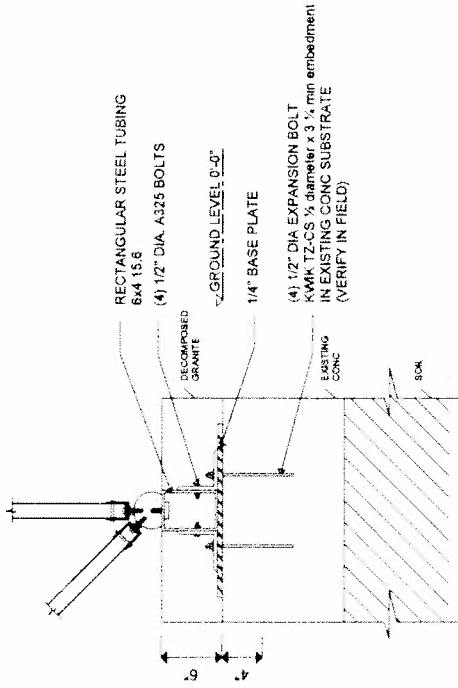

2.1 TYP CONCRETE SLAB ANCHORING F5
 SECTION

SCALE: 1" = 1'-0"

FOUNDATION DETAILS

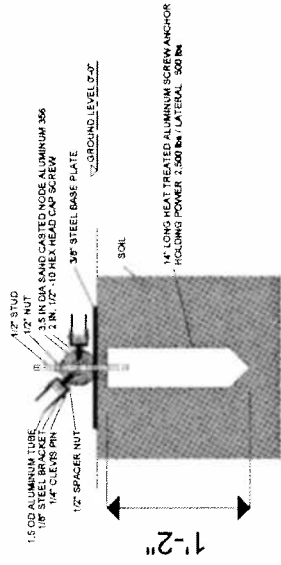

1.0 TYP CONCRETE SLAB ANCHORING E4
PLAN

SCALE: 1" = 1'-0"

FOUNDATION DETAILS

A7.5

Rock
VENTURES LLC

X

СИ-ШАРШОБОТ

A network of Activations linked in 2-minute-walk intervals

STEREObOT ACTIVATION TECHNOLOGY
ROCK VENTURES EXPERIENCE DESIGN

connecting
800,000
visitors
to downtown Detroit

STEREOTYPED ACTIVATION TECHNOLOGY
ROCK VENTURES EXPERIENCE DESIGN

DETROIT



United Nations
Educational, Scientific and
Cultural Organization

CITY OF DESIGN

BRANDING EMBLEM

STEREOTACTIC TECHNOLOGY
ROCK VENTURES EXPERIENCE DESIGN

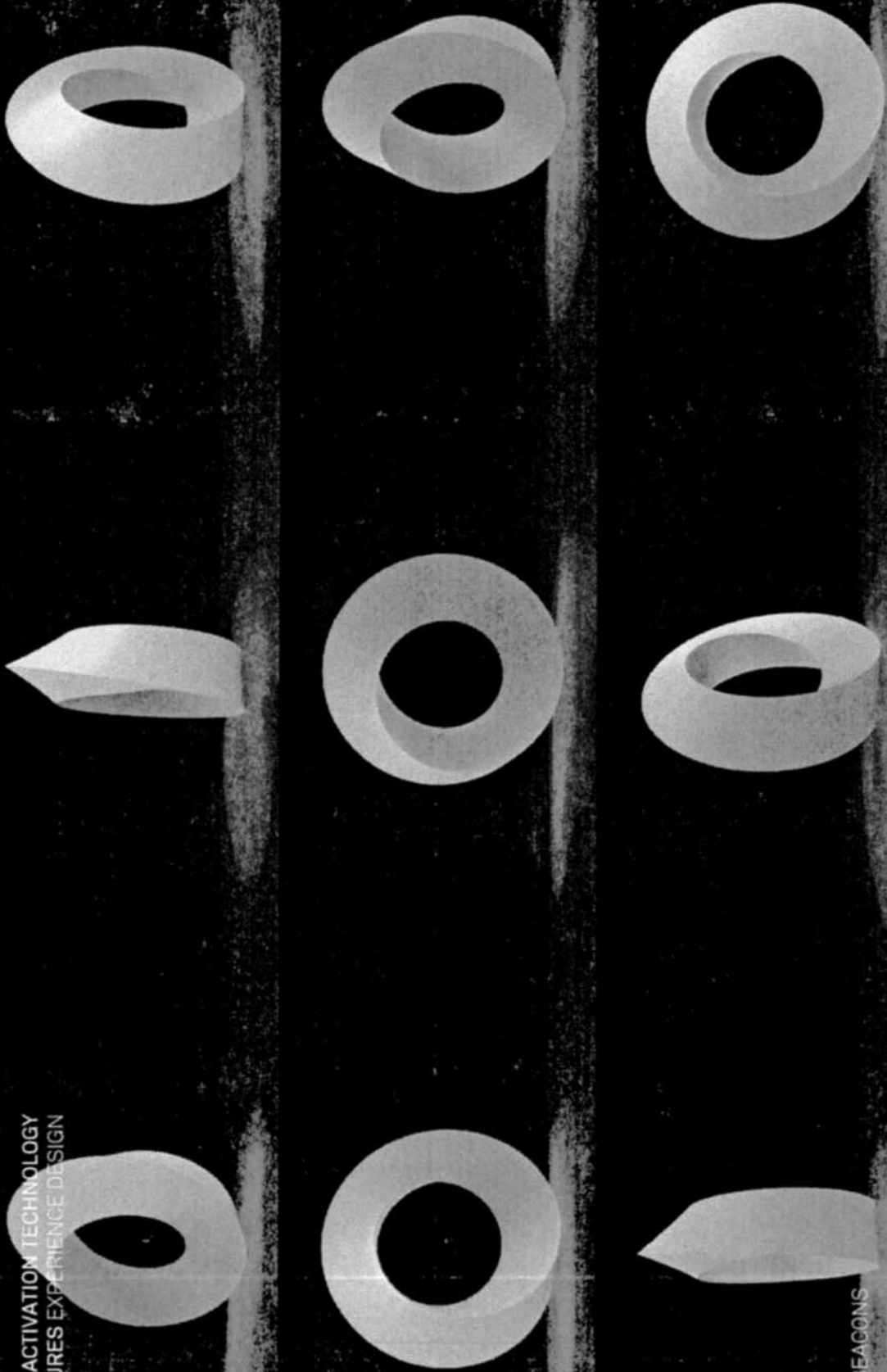

BRANDING BEACONS

STEREOTYPICAL ACTIVATION TECHNOLOGY ROCK VENTURES EXPERIENCE DESIGN

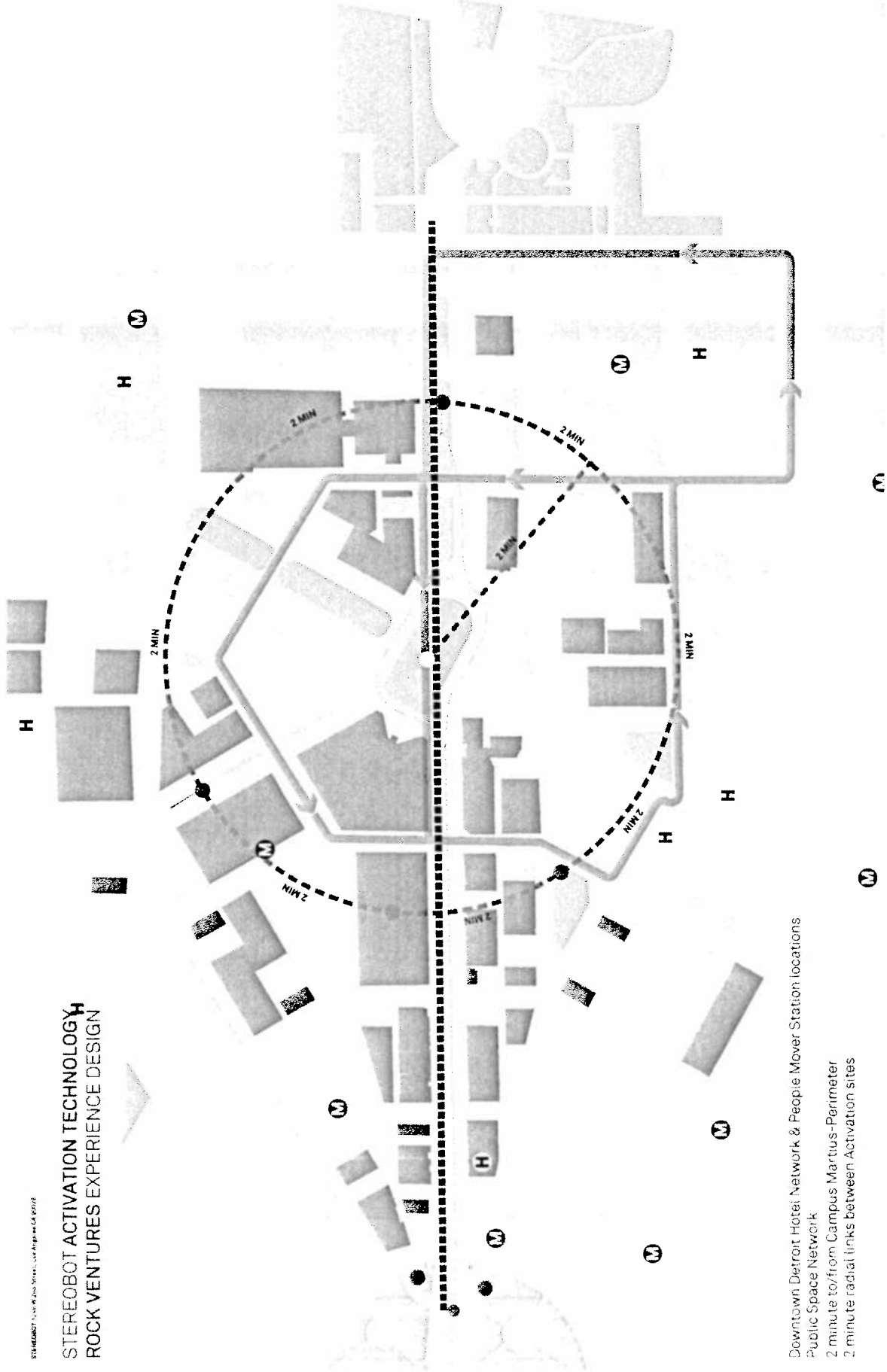

- Downtown Detroit Hotel Network & People Mover Station locations
- Public Space Network
- 2 minute to/from Campus Martius-Perimeter
- 2 minute radial links between Activation sites

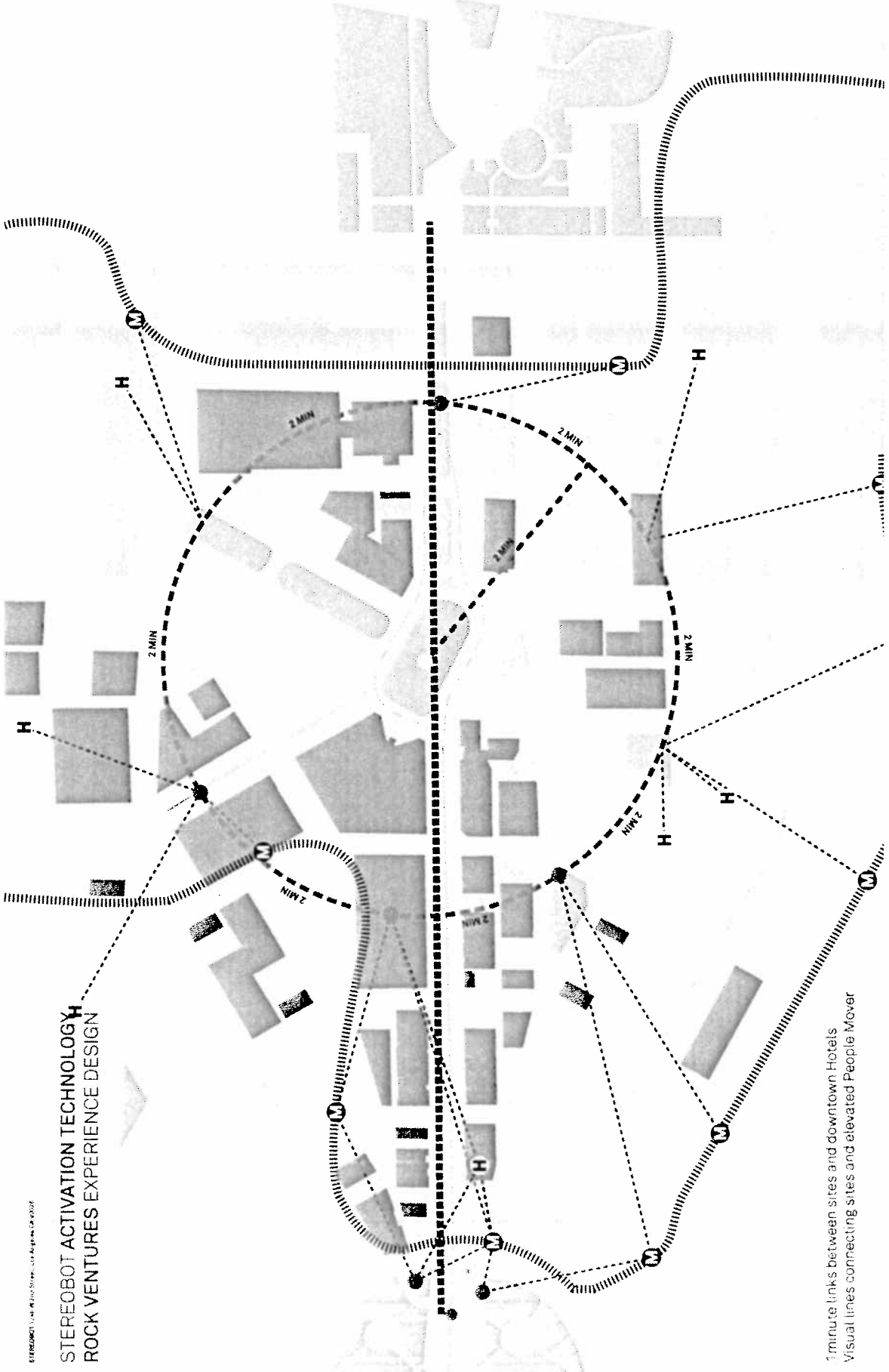

STEREObot ACTIVATION TECHNOLOGY
 ROCK VENTURES EXPERIENCE DESIGN

1 minute links between sites and downtown Hotels
 Visual lines connecting sites and elevated People Mover

STEREOTEC ACTIVATION TECHNOLOGY ROCK VENTURES EXPERIENCE DESIGN

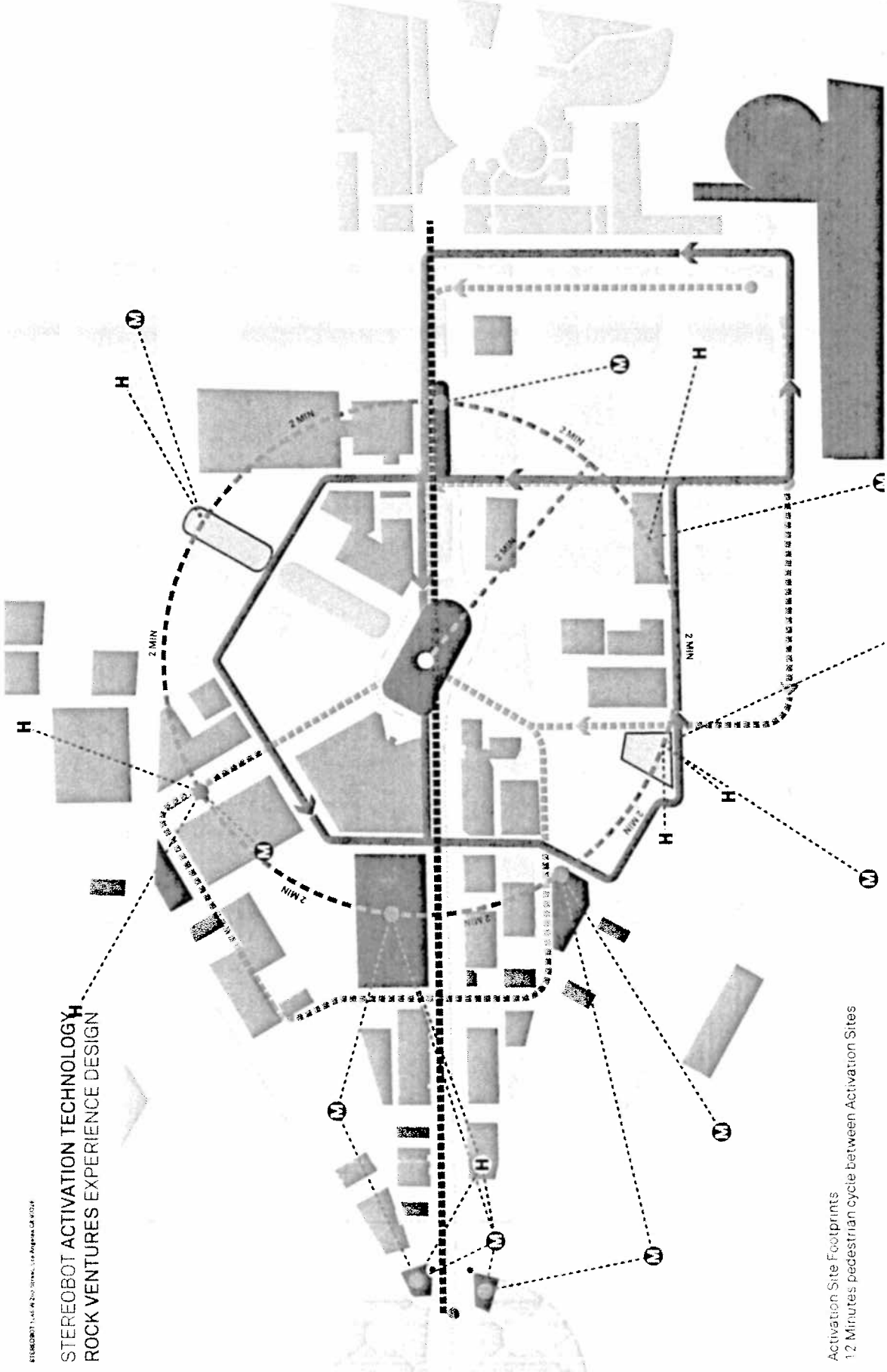

Activation Site Footprints
12 Minutes pedestrian cycle between Activation Sites

STEREOBOT ACTIVATION TECHNOLOGY ROCK VENTURES EXPERIENCE DESIGN

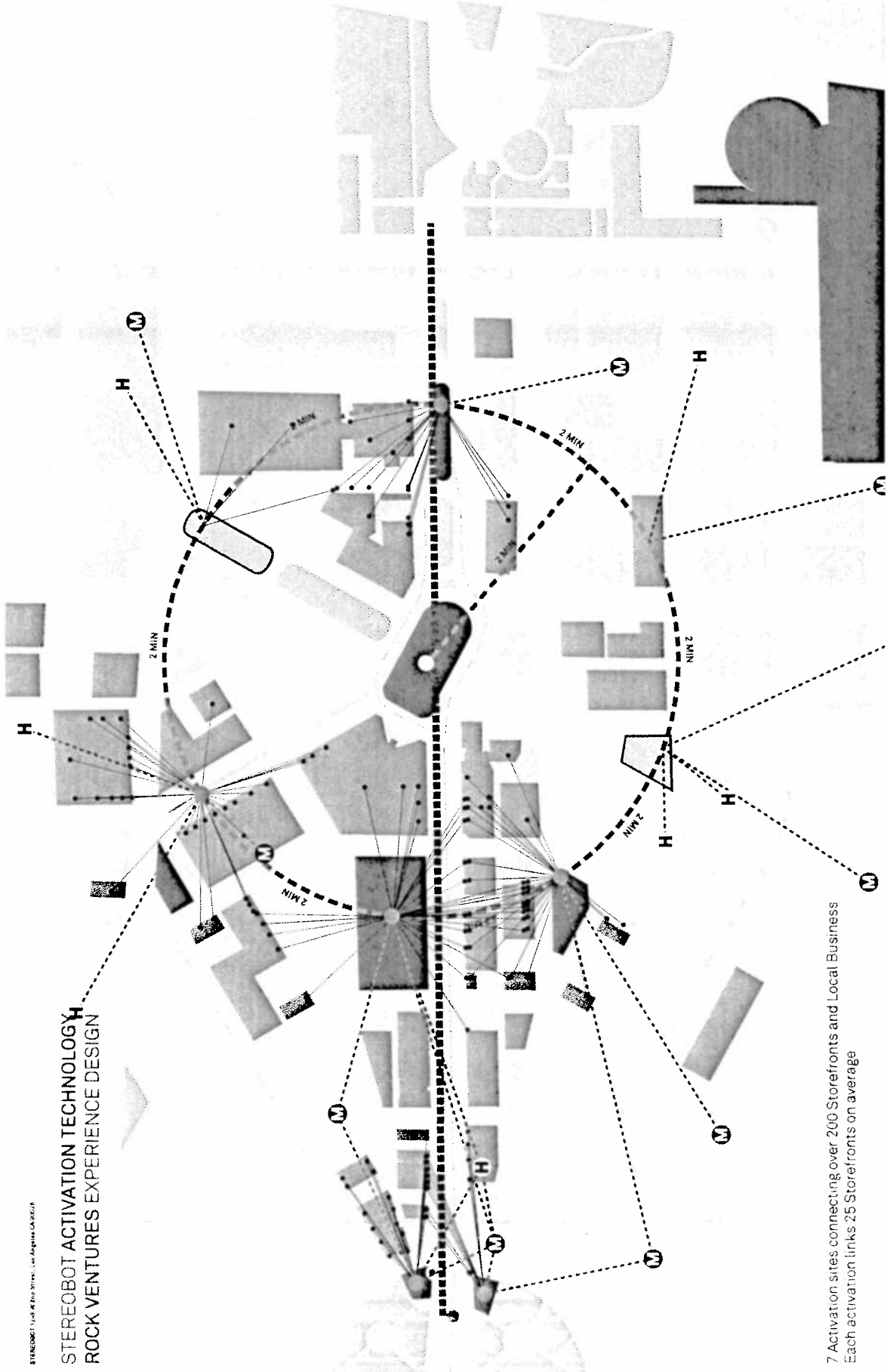

7 Activation sites connecting over 200 Storefronts and Local Business
Each activation links 25 Storefronts on average

STEREBOBOT ACTIVATION TECHNOLOGY ROCK VENTURES EXPERIENCE DESIGN

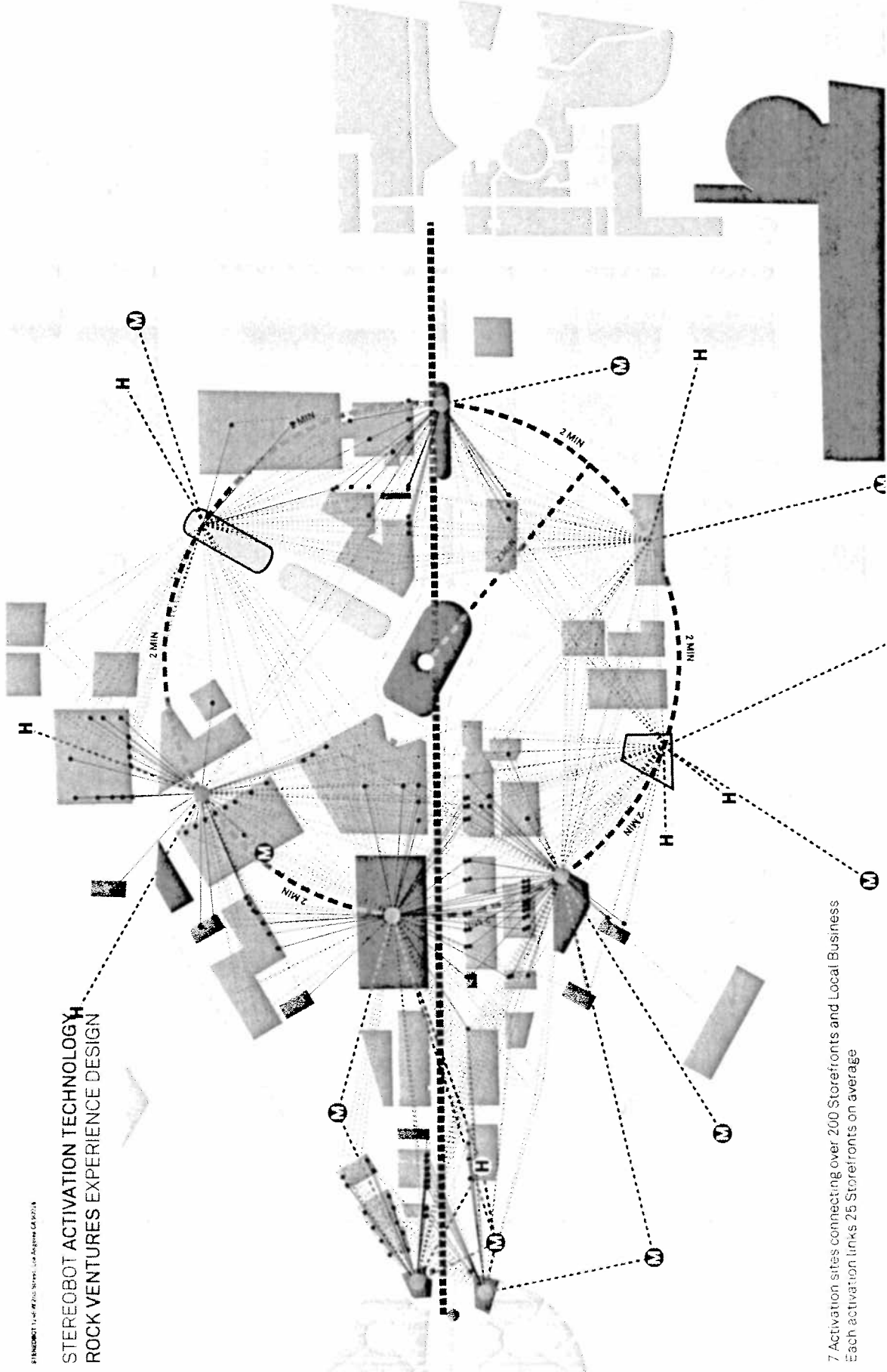

7 Activation sites connecting over 200 Storefronts and Local Business
Each activation links 25 Storefronts on average

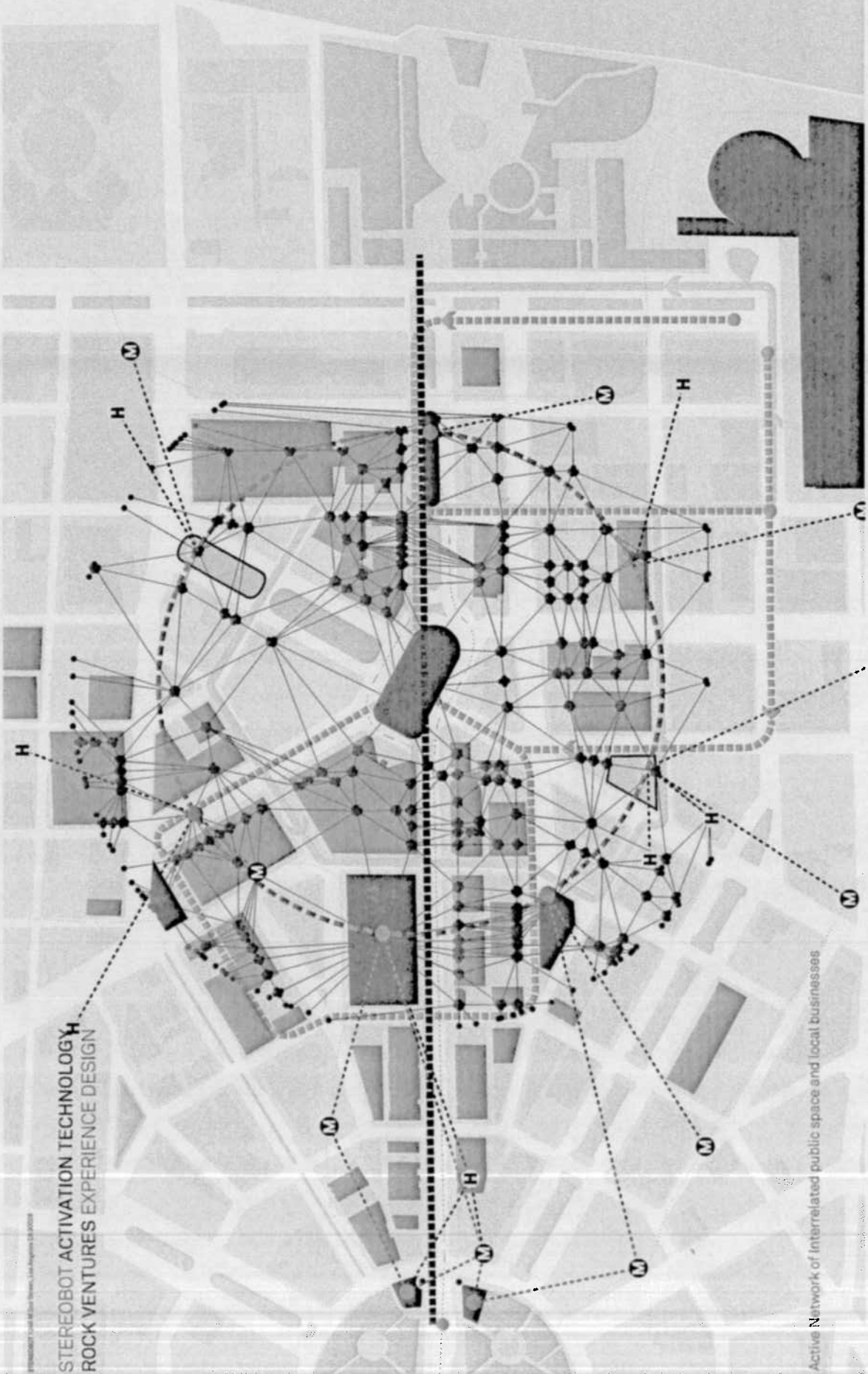

STEREOBOT ACTIVATION TECHNOLOGY
 ROCK VENTURES EXPERIENCE DESIGN

Active Network of interrelated public space and local businesses

STEREOTEC ACTIVATION TECHNOLOGY ROCK VENTURES EXPERIENCE DESIGN

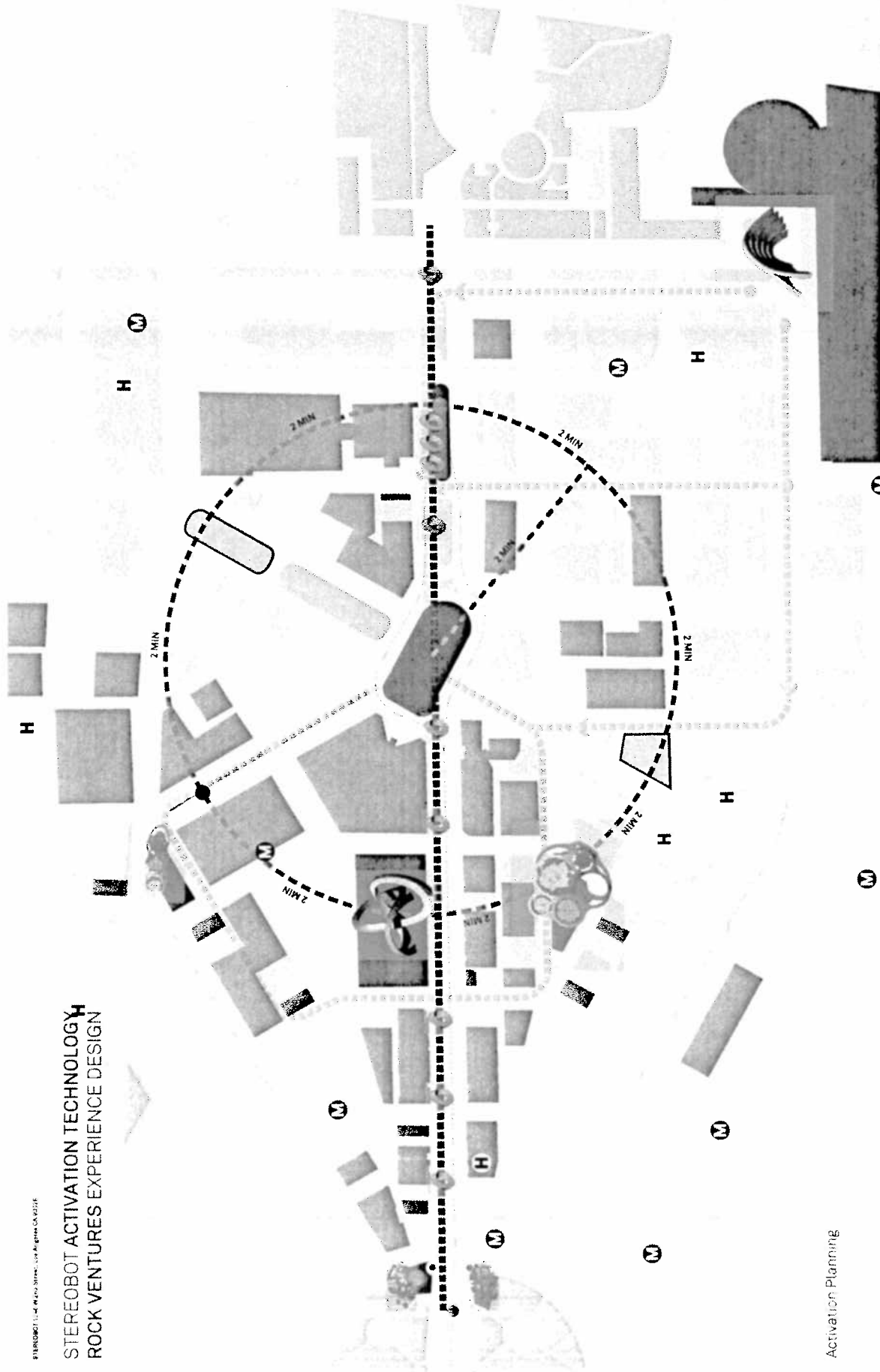

STEREOTACTIC TECHNOLOGY ROCK VENTURES EXPERIENCE DESIGN

STRUCTURE SCALE ANALYSIS

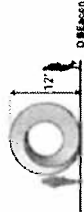
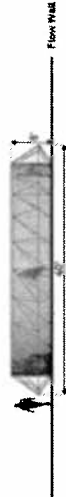
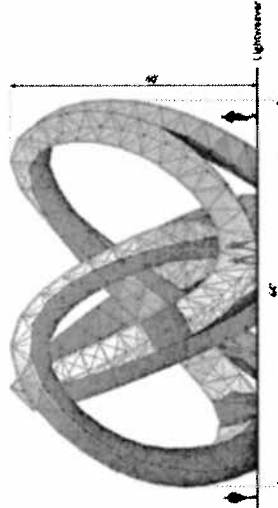
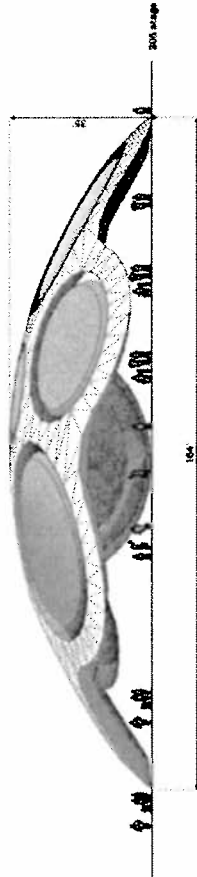

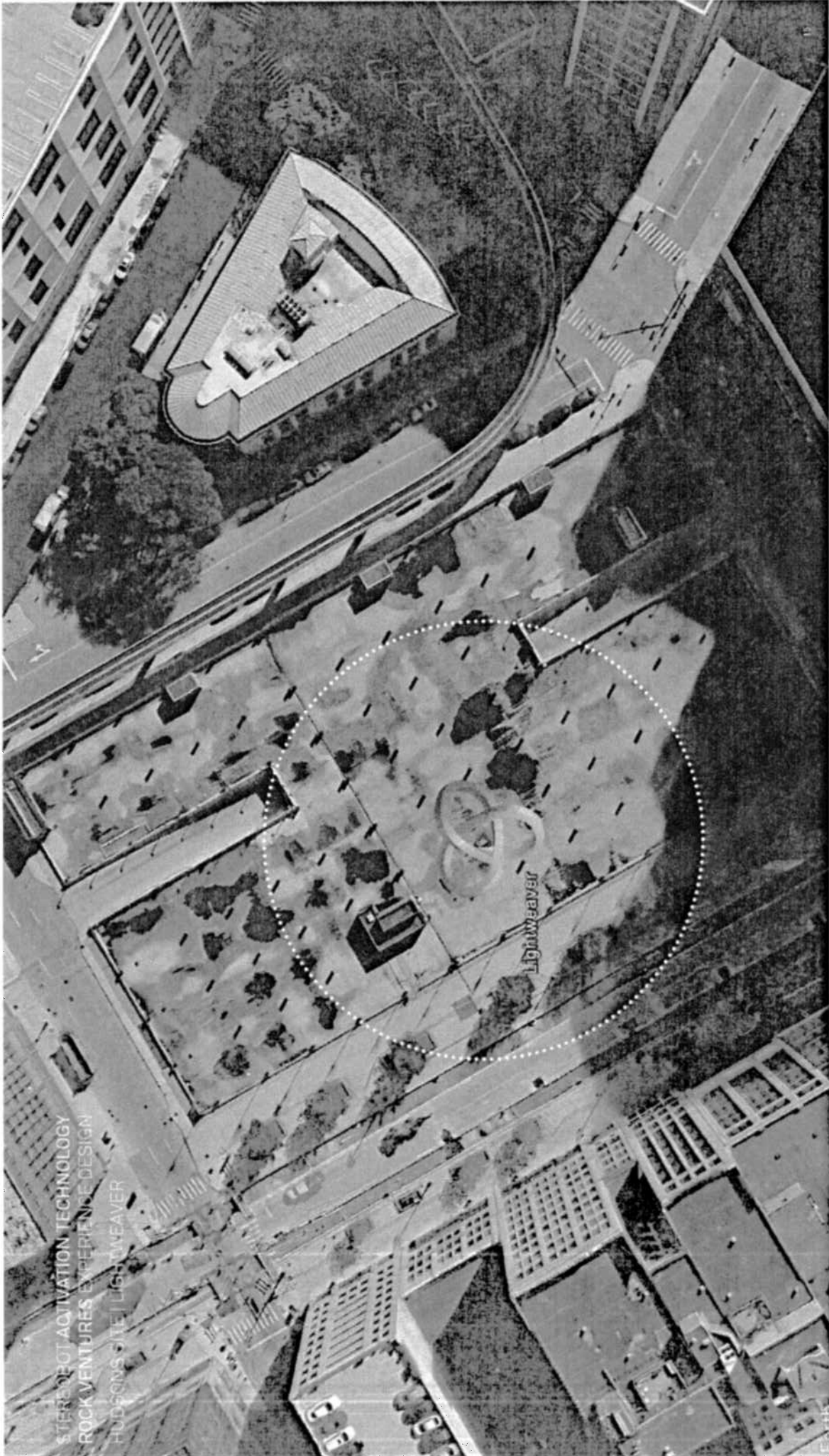

STEREOPOT ACTIVATION TECHNOLOGY
ROCK VENTURES EXPERIENCE DESIGN
HUDSON'S SITE | LIGHTWEAVER

STEREOTACTIC ACTIVATION TECHNOLOGY ROCK VENTURES EXPERIENCE DESIGN

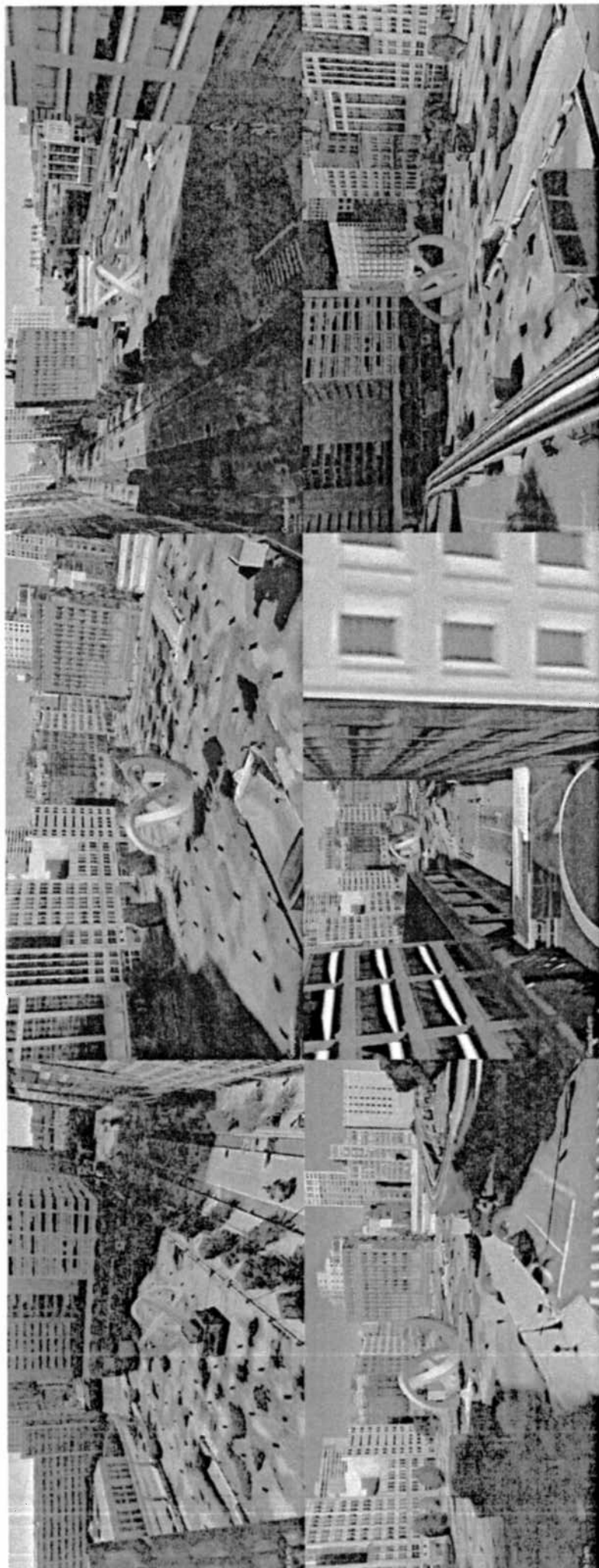

STEREOBOT ACTIVATION TECHNOLOGY
ROCK VENTURES EXPERIENCE DESIGN
LIGHTWEAVER

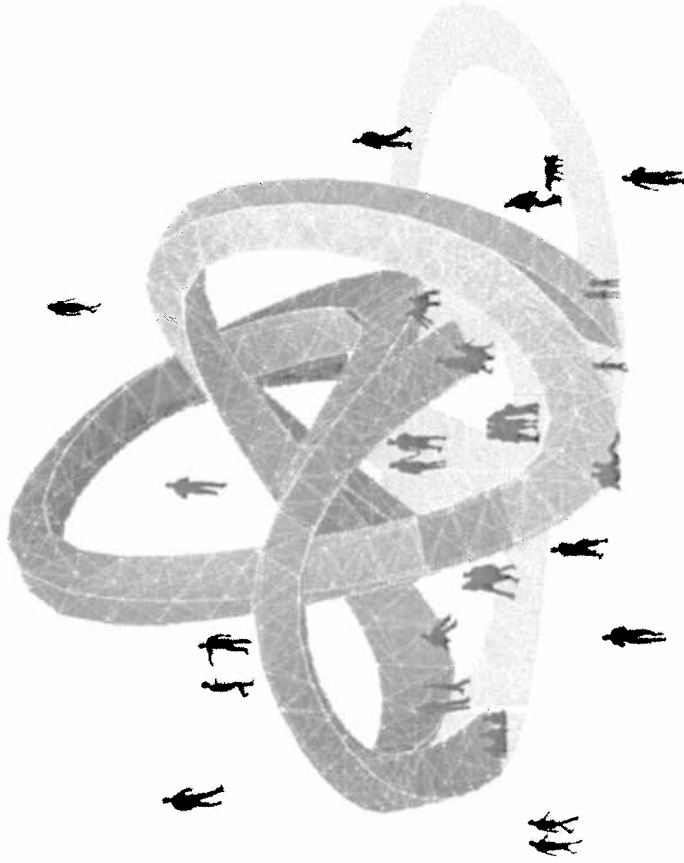
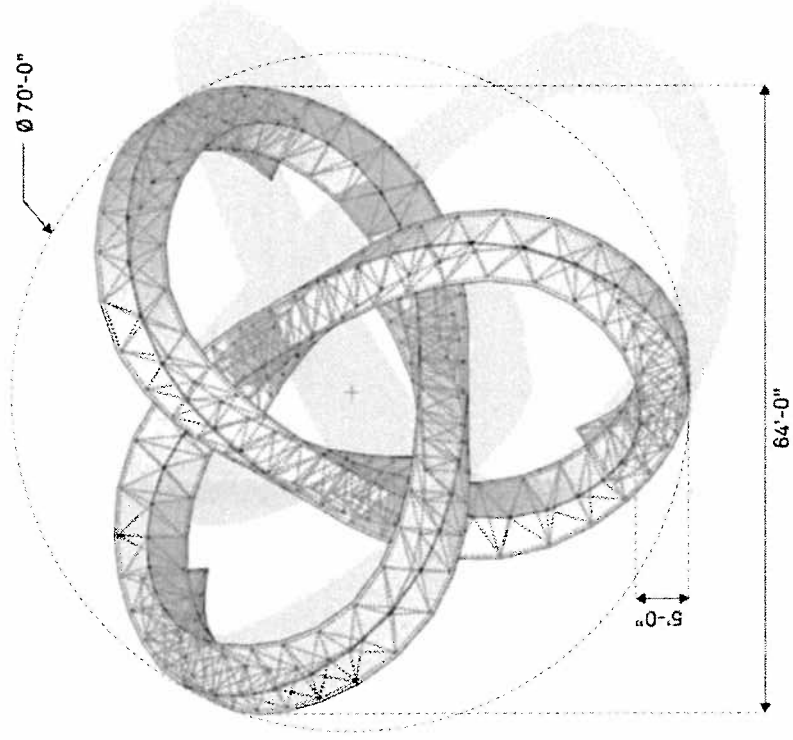

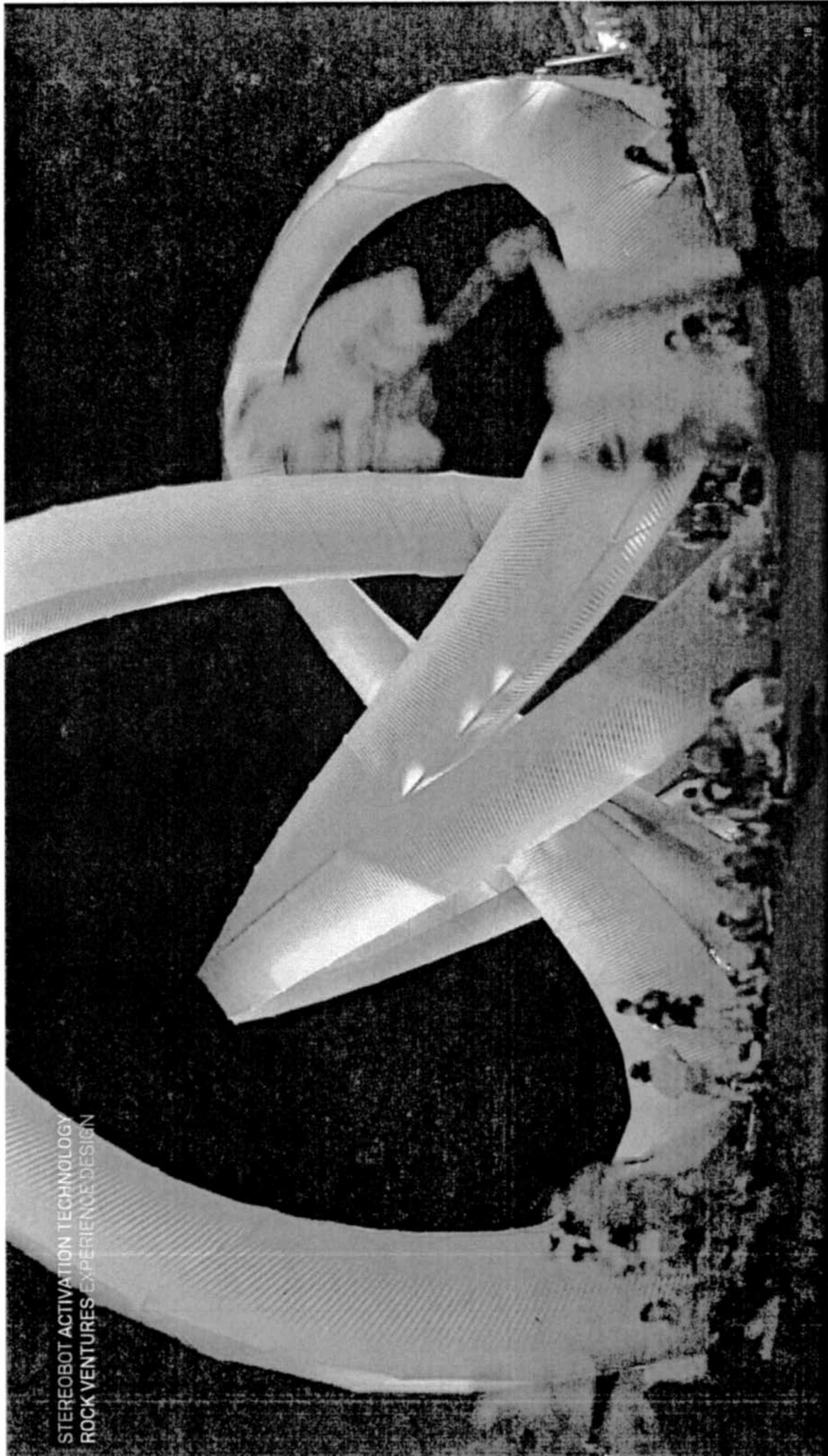

STEREObOT ACTIVATION TECHNOLOGY
ROCK VENTURES EXPERIENCE DESIGN



STEREOBOT ACTIVATION TECHNOLOGY
ROCK VENTURES EXPERIENCE DESIGN

COBO CENTER | GATEWAY

STEREOPLOT ACTIVATION TECHNOLOGY
ROCK VENTURES EXPERIENCE DESIGN
COBO CENTER | GATEWAY LOCATION OPTION 1

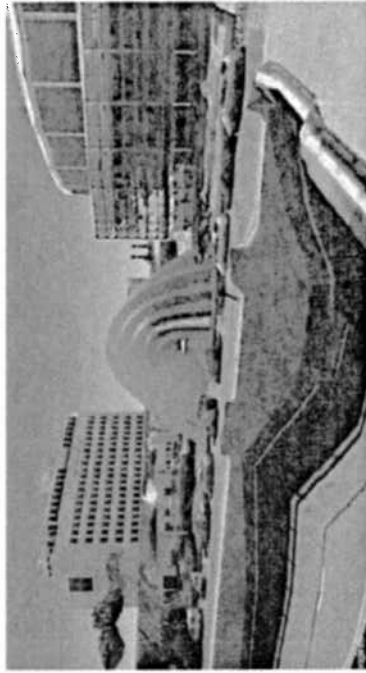
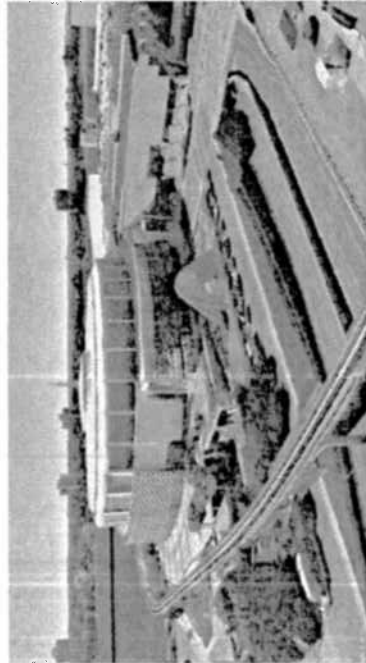



STREET ACTIVATION TECHNOLOGY
ROCK VENTURES EXPERIENCE CENTER
JEFFERSON AVE - MADISON AVE

STEREOTYPE ACTIVATION TECHNOLOGY
ROCK VENTURES EXPERIENCE DESIGN

JEFFERSON AVE - WOODWARD | GATEWAY LOCATION OPTION 2

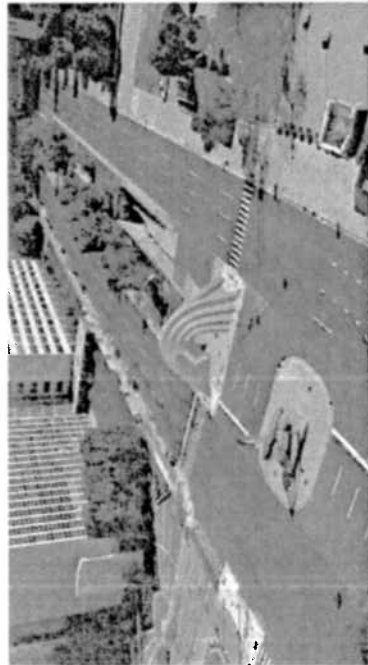

STEREOTYPICAL ACTIVATION TECHNOLOGY
ROCK VENTURES EXPERIENCE DESIGN
GATEWAY

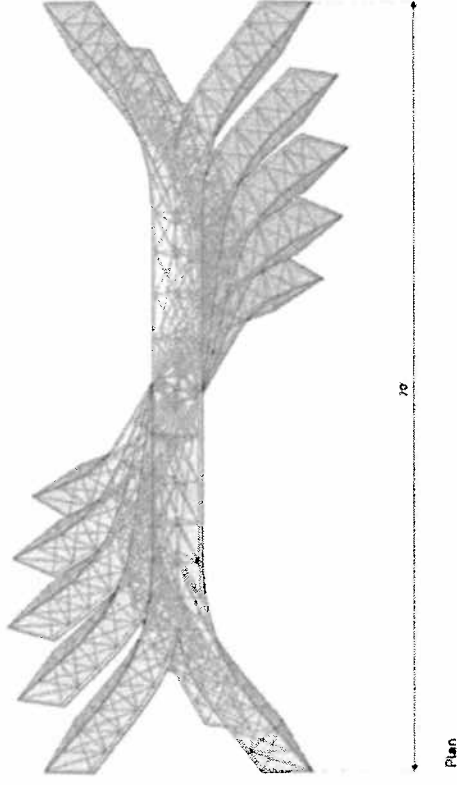
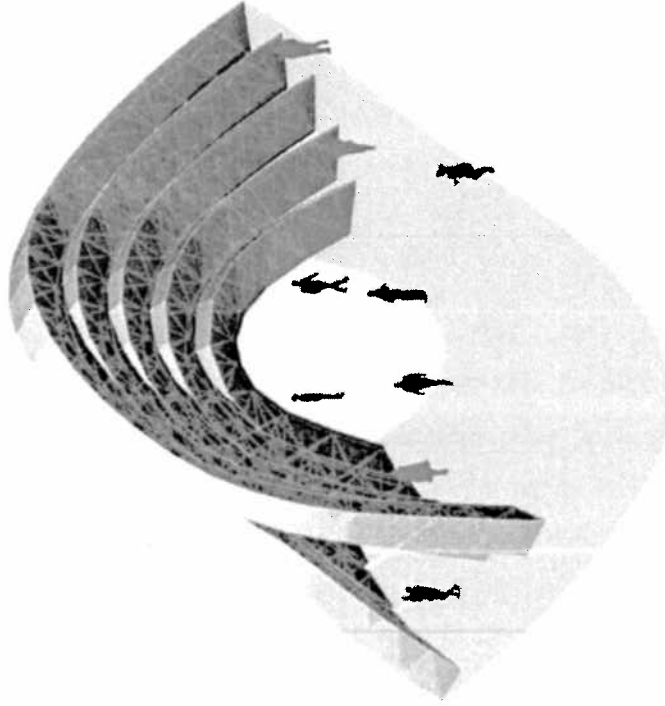

STEREObOT ACTIVATION TECHNOLOGY
ROCK VENTURES EXPERIENCE DESIGN

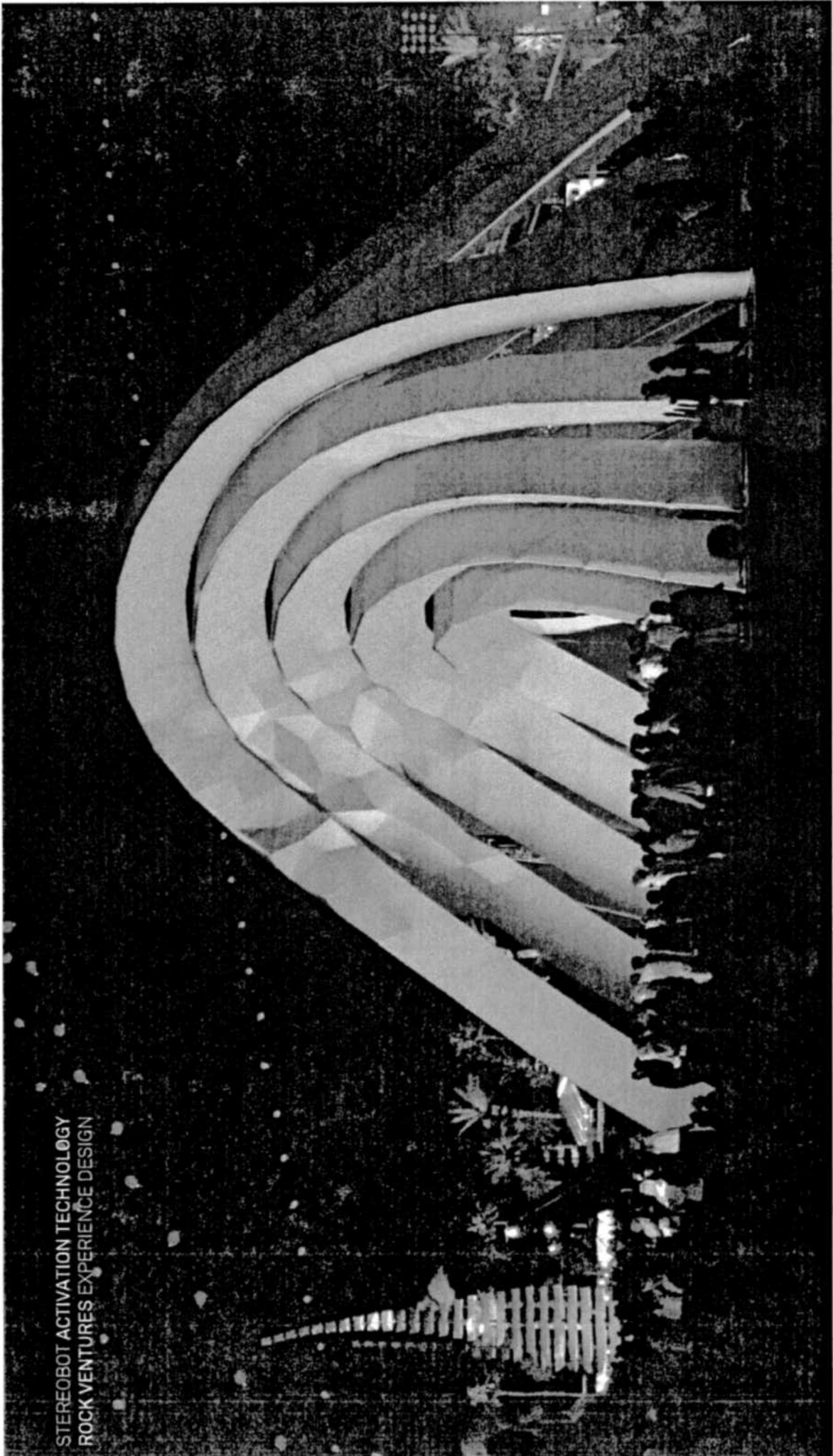

STEREOBOT ACTIVATION TECHNOLOGY
ROCK VENTURES EXPERIENCE DESIGN



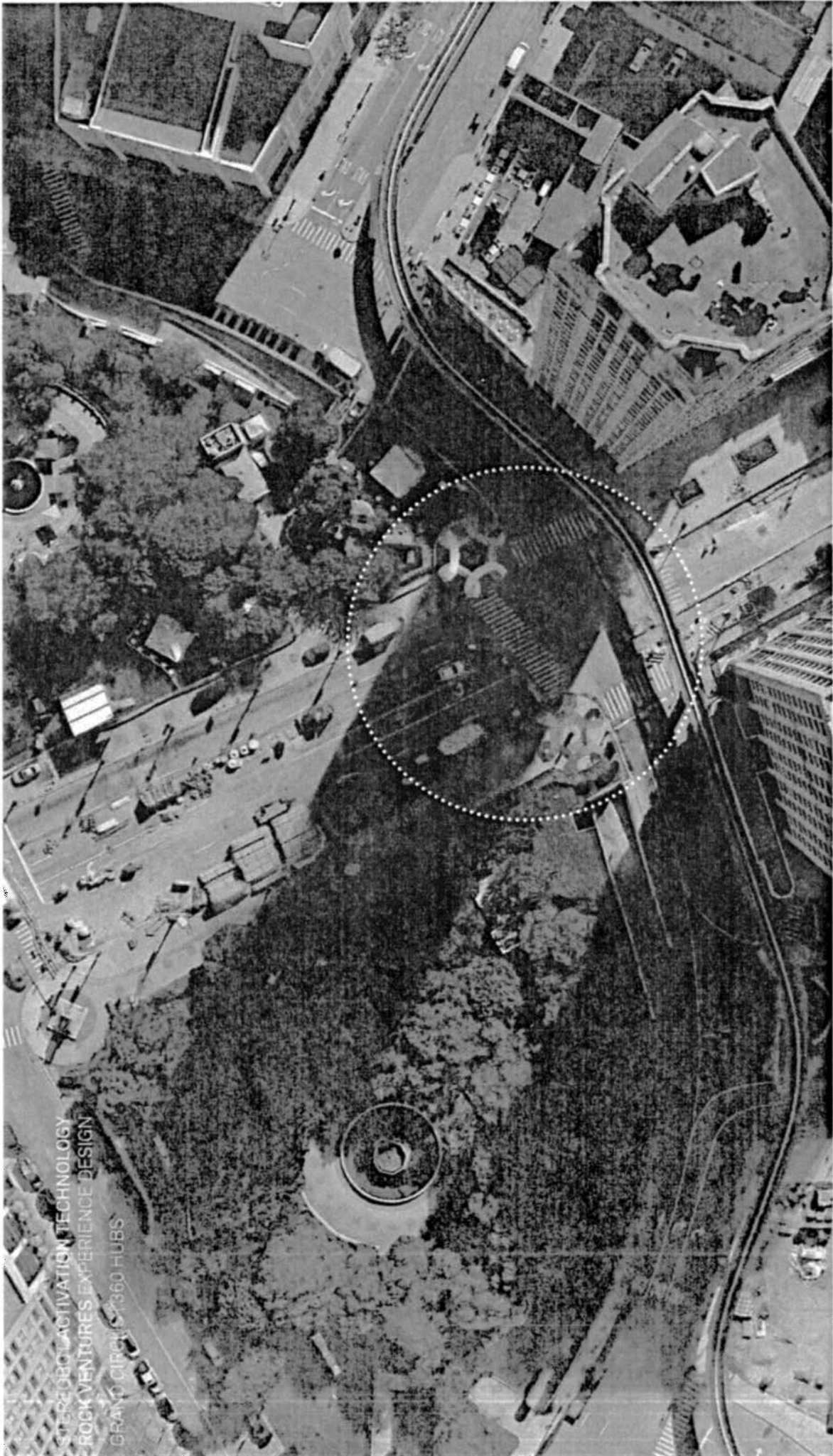

SITE REBROU/ACTIVATION TECHNOLOGY
ROCK VENTURES EXPERIENCE DESIGN
GRAND CIRCLE (S) 360 HUBS

STEREOPOT ACTIVATION TECHNOLOGY
ROCK VENTURES EXPERIENCE DESIGN

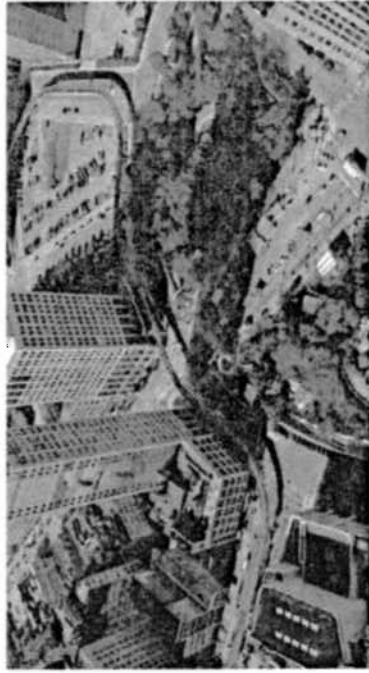

STEREOTOPT ACTIVATION TECHNOLOGY
ROCK VENTURES EXPERIENCE DESIGN

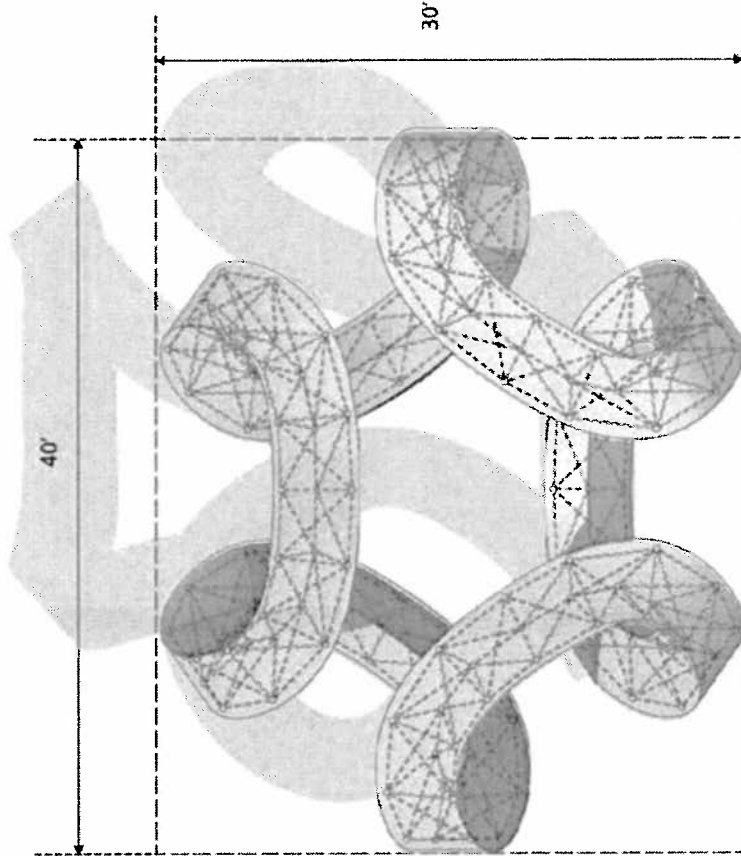
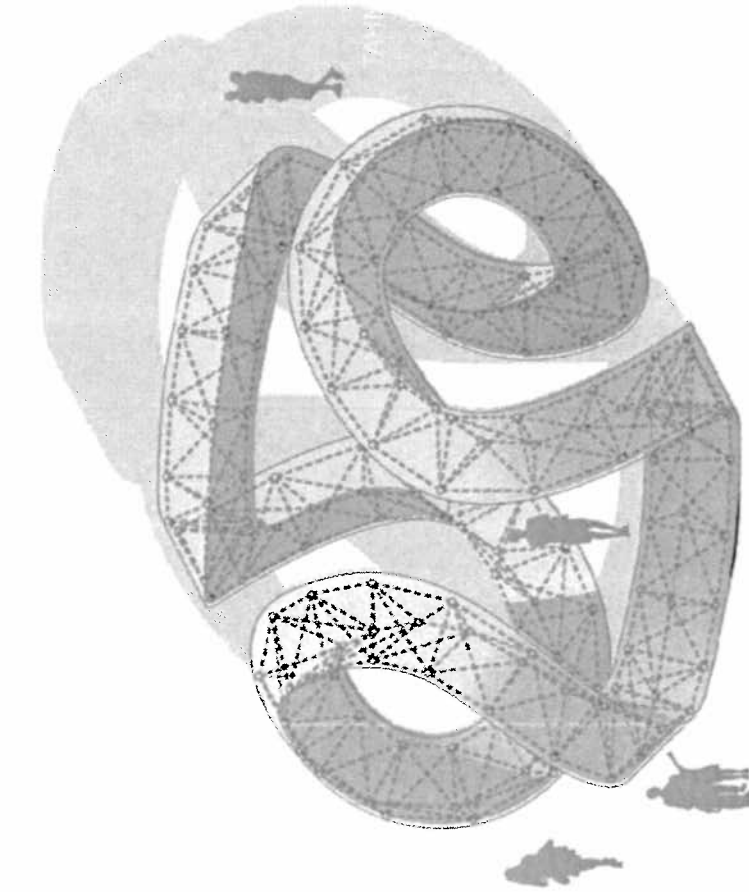

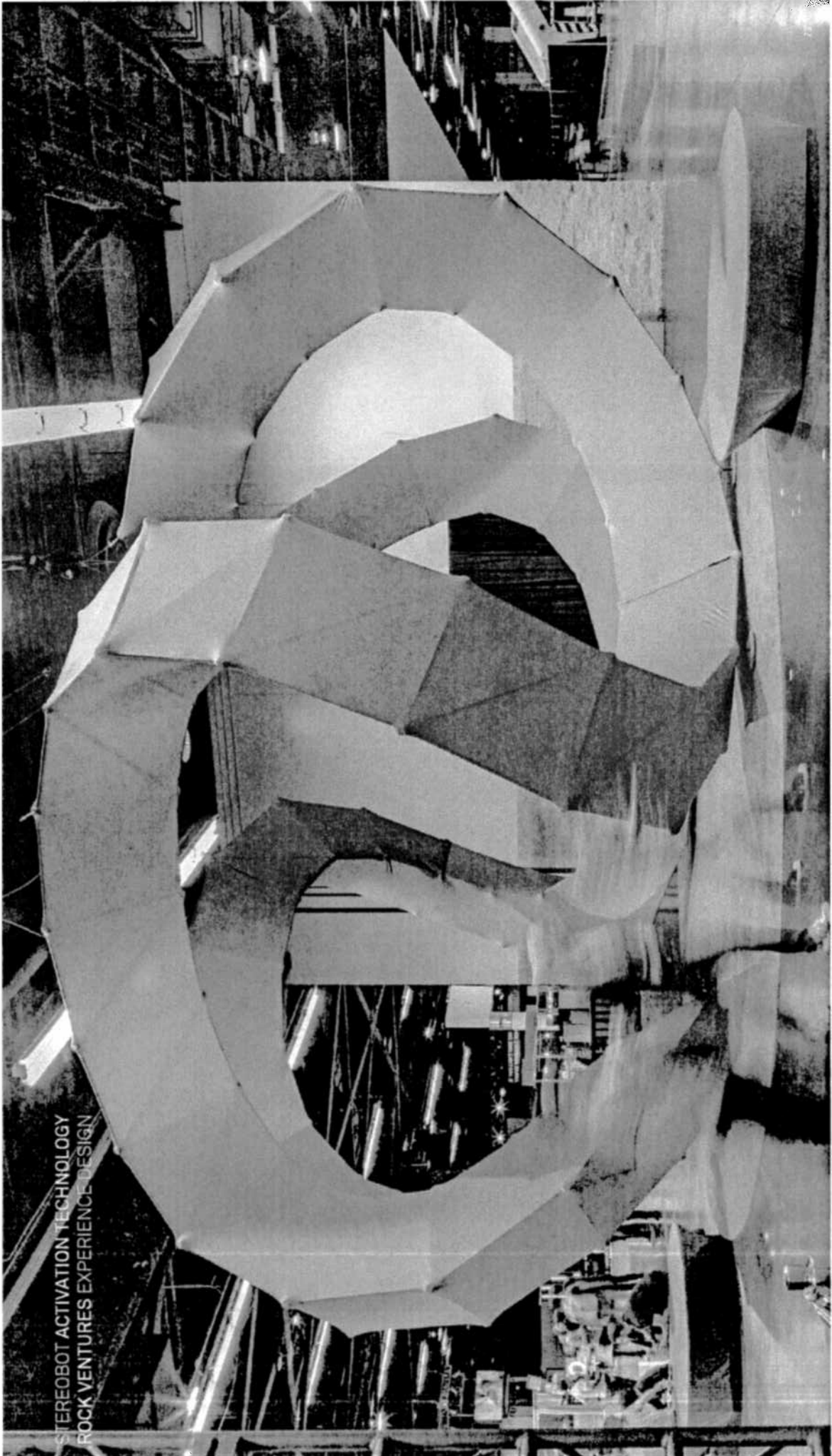

STEREOTOP ACTIVATION TECHNOLOGY
ROCK VENTURES EXPERIENCE DESIGN



STRATEGY ACTIVATION TECHNOLOGY
ROCKMOUNTAIN EXPERIENCE DESIGN
MONTE AND RANDOLPH ST. MARCA

Google Earth

STEREOBOT ACTIVATION TECHNOLOGY ROCK VENTURES EXPERIENCE DESIGN



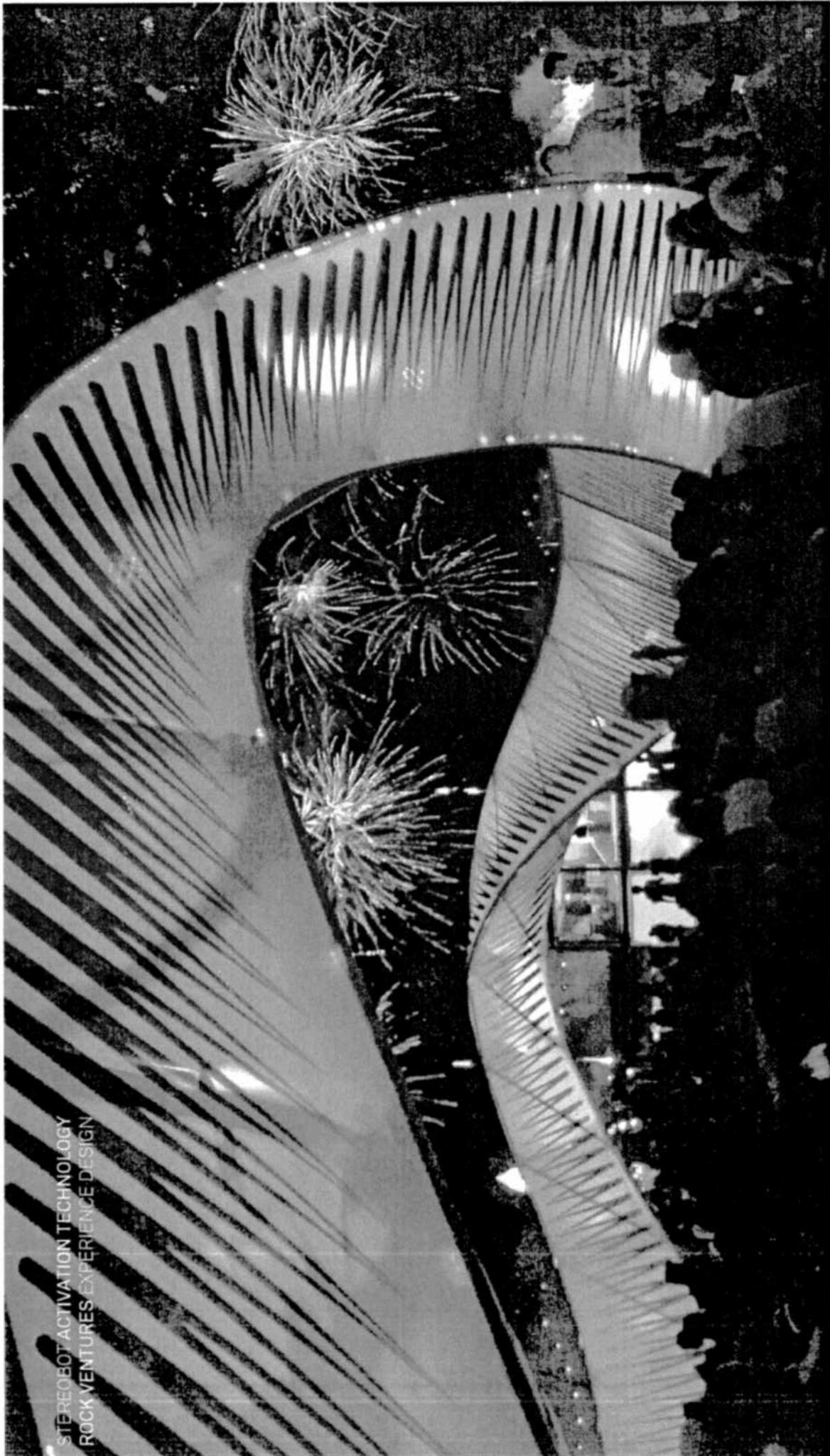

STEREOTYPICAL ACTIVATION TECHNOLOGY
ROCK VENTURES EXPERIENCE DESIGN

STEREOMET ACTIVATION TECHNOLOGY
ROCK VENTURES EXPERIENCE DESIGN
WOODWARD AVENUE | 180 BEACON

The 180Beacon system is a free-standing, multifunctional display featuring a lightweight modular frame and rich, full-color printed media and lighting.

The 180Beacon functions as brand emblem, eye-some, guiding element. Multiple 180Beacons visually link locations along a path and define a clear urban trajectory, or trail of crumbs, along Woodward Avenue from Jefferson Ave to Circus Park.

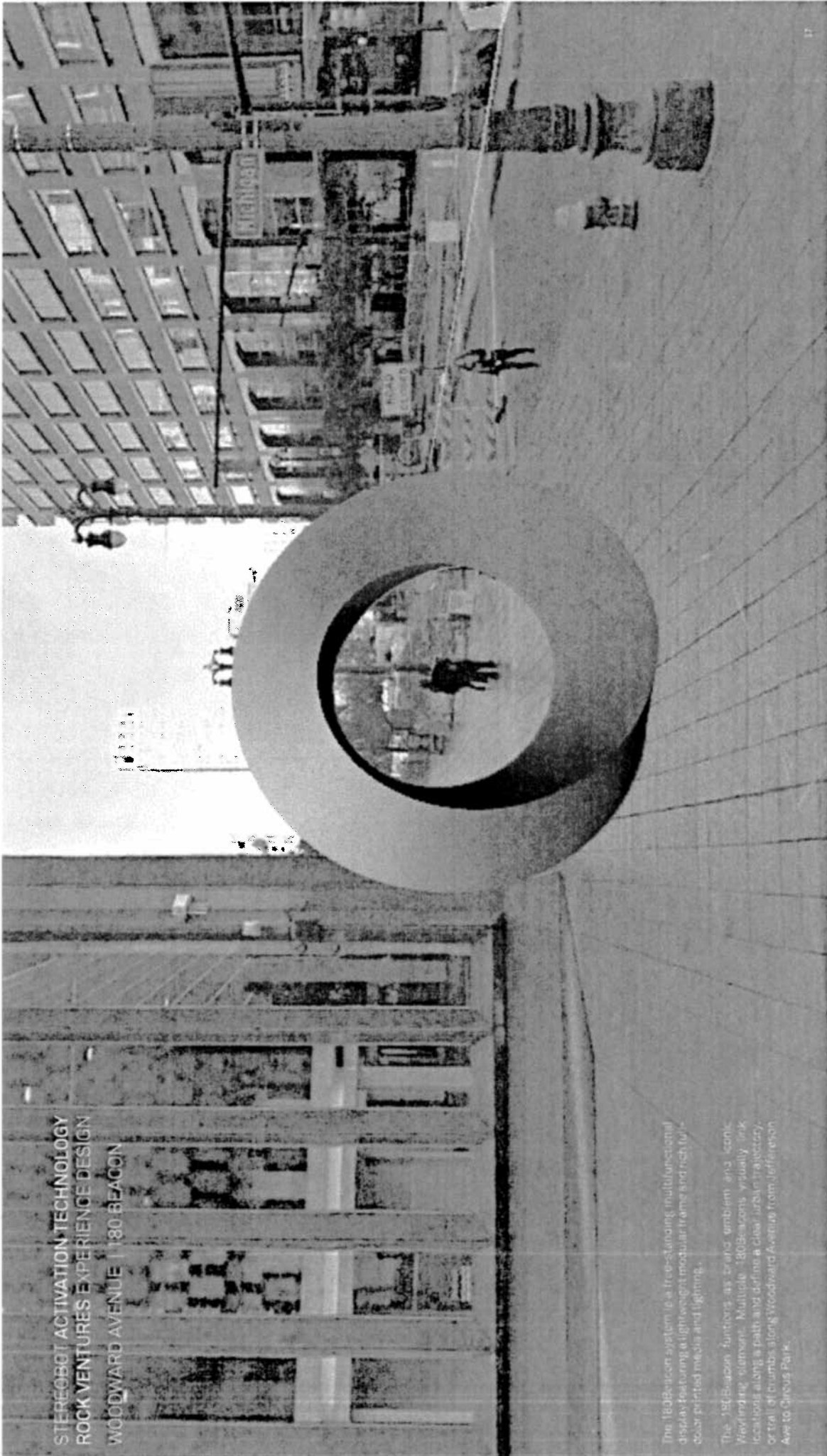

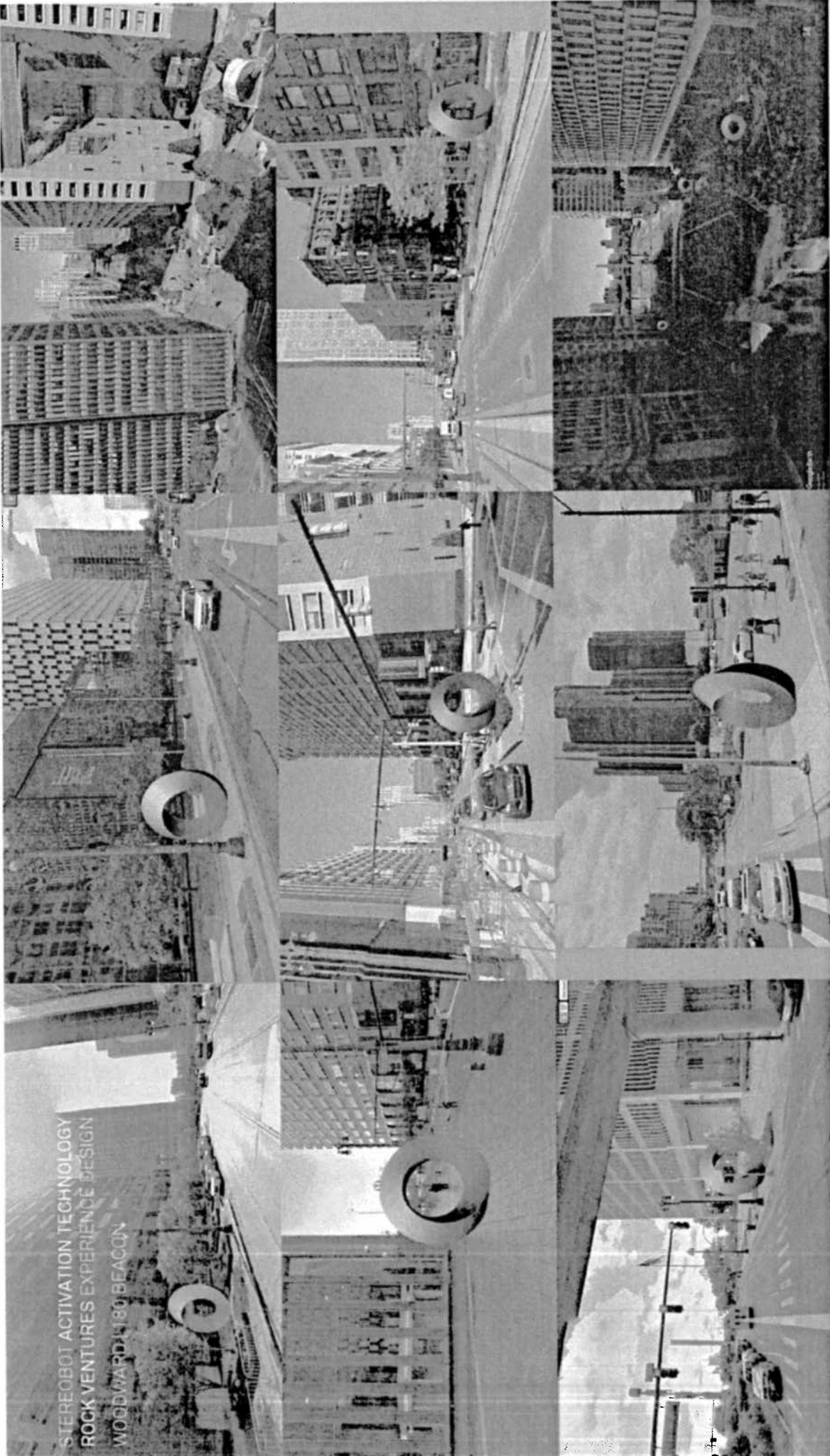

STEREOBOT ACTIVATION TECHNOLOGY
ROCK VENTURES EXPERIENCE DESIGN
WOODWARD/180 BEACON

STEREOTYPE ACTIVATION TECHNOLOGY
ROCK VENTURES EXPERIENCE DESIGN

