

City of Detroit
**City Engineering Division, Department of Public Works
Survey Bureau**

NOTICE OF PROPOSED CHANGE IN PROPERTY

Date: 03/29/2016

Petition: x1031

- | | |
|--|--|
| <input type="checkbox"/> AT&T Telecommunication | <input type="checkbox"/> Berm Use |
| <input type="checkbox"/> Comcast Television (CATV) | <input type="checkbox"/> Conversion to Easement |
| <input type="checkbox"/> Detroit Edison (DTE) | <input type="checkbox"/> Dedication |
| <input type="checkbox"/> Fire Department | <input checked="" type="checkbox"/> Encroachment |
| <input type="checkbox"/> Michcon (DTE) | <input type="checkbox"/> Temporary Closing |
| <input type="checkbox"/> Planning & Development Department | <input type="checkbox"/> Vacation |
| <input type="checkbox"/> Public Lighting Authority | |
| <input type="checkbox"/> Public Lighting Department | |
| <input type="checkbox"/> Police Department | |
| <input type="checkbox"/> Recreation Department | |
| <input type="checkbox"/> Solid Waste Division, DPW | |
| <input type="checkbox"/> Street Design Bureau, DPW | |
| <input checked="" type="checkbox"/> Street Maintenance Division, DPW | |
| <input type="checkbox"/> Traffic Engineering Division, DPW | |
| <input type="checkbox"/> Water and Sewerage Department | |
| <input type="checkbox"/> _____ | |

A petition drawing is attached. Property shown on the attached print is proposed to be changed as indicated. Kindly report (using the back of this sheet) the nature of your services, if any affected by the proposed change and the estimated costs of removing and rerouting such services (if necessary).

Please return one copy to City Engineering Division, DPW within two weeks of the submittal date. Retain one copy and print for you file.

Ron Brundidge, Director, Department of Public Works

By: Richard Doherty, CED DPW
City Engineer

**TO: City Engineering Division, DPW
2 Woodward Ave., Suite 642
Detroit, Michigan 48226-3462
Survey Bureau: 313-224-3970**

Petition: x1031

The proposed change in property (referred to on the other side of this sheet) would affect our services as follows:

Not Involved

Involved; but asking you to hold action on this petition until further notice.

Involved; but no objections to the property change.

Involved; but no objections to the property change...provided as easement of the full width of the public right-of-way (street, alley or other public place) is reserved.

Involved; the nature of our services and the estimated costs of removing and/or rerouting such services are:

DPW / Street Maintenance Division
(Utility or City Department)

Dhaval Patel
By 

Supervisor
Title

4/1/2016
Date

(313) 224-0021
Area code – Telephone number

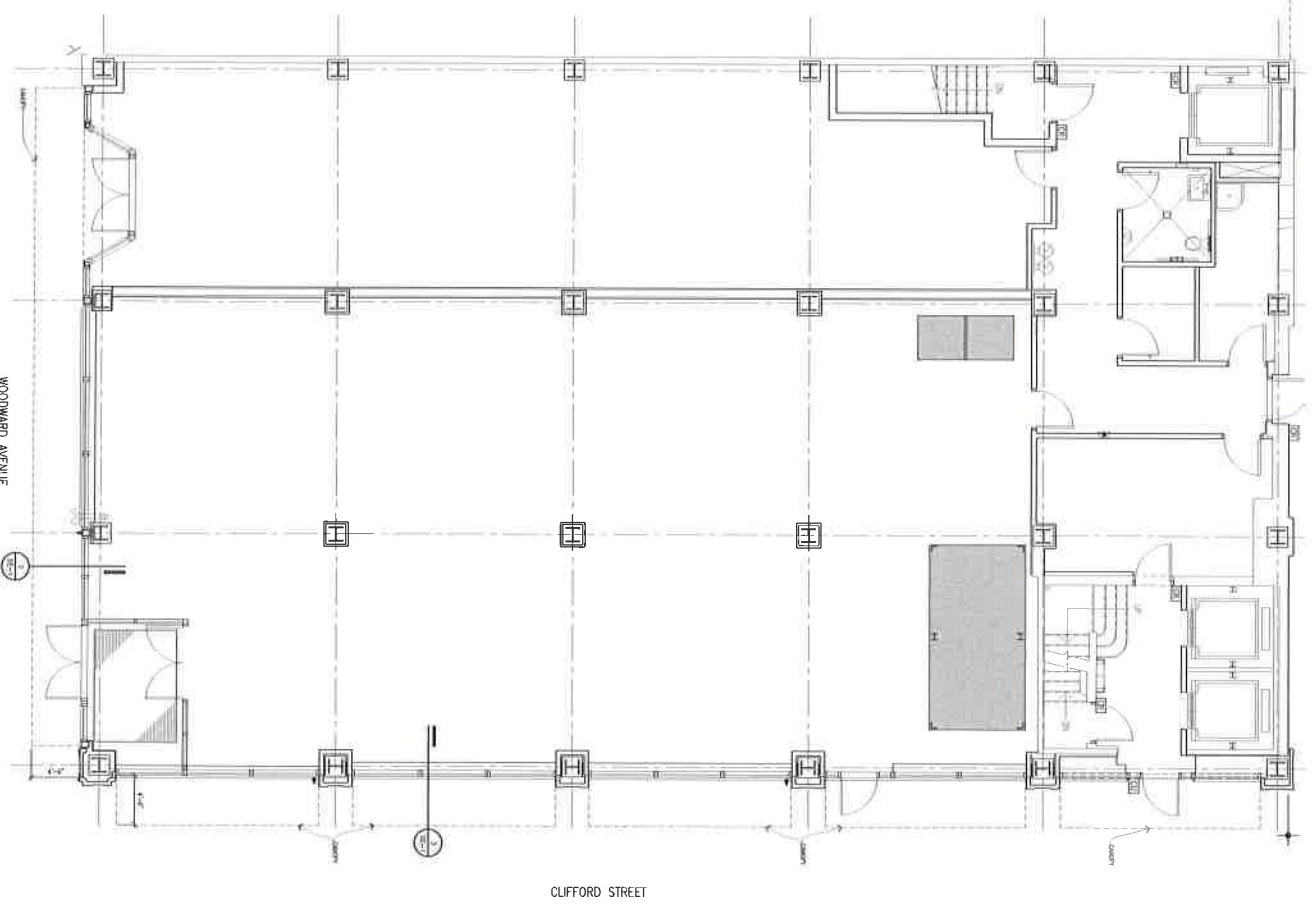

SECTION 1
CLIFFORD STREET TO CLIFFORD STREET

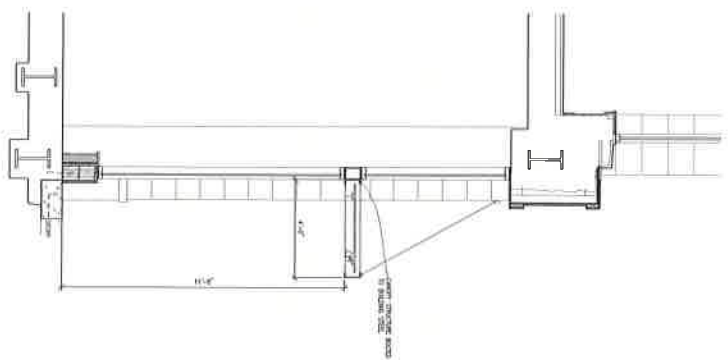

SECTION 2
CLIFFORD SECTION VIEW

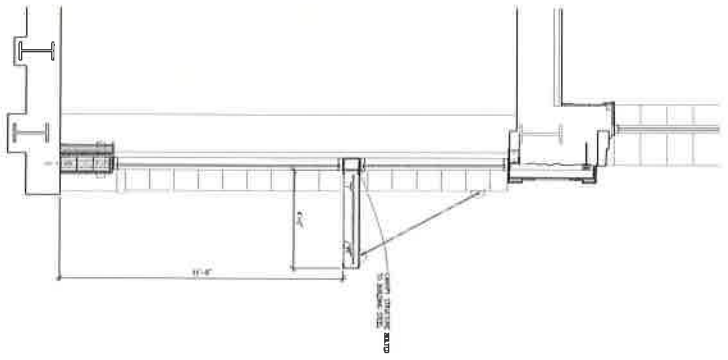

SECTION 3
WOODWARD SECTION VIEW

SECTION 4
CANOPY ATTACHMENT LAYOUT

DATE	DESCRIPTION
2014200	CLIFFORD SECTION VIEW
2014200	WOODWARD SECTION VIEW
2014200	CANOPY ATTACHMENT LAYOUT

Scale: AS NOTED
SE-1

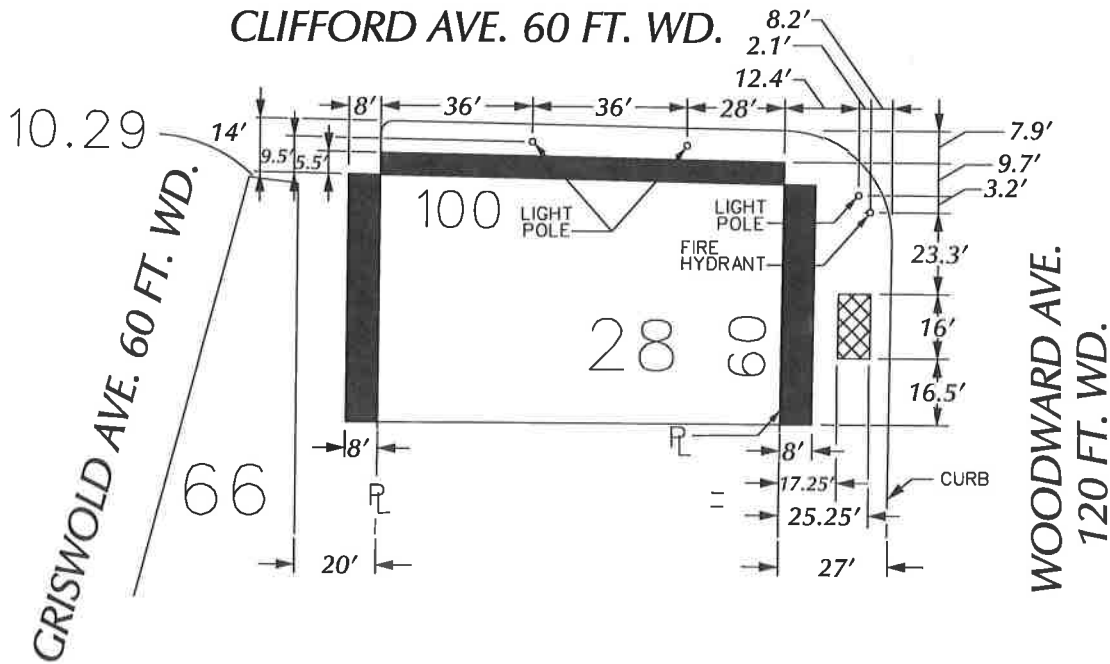

PETITION NO. 1031
 GIFFELS WEBSTER
 28 W. ADAMS, SUITE 1200
 DETROIT, MICHIGAN 48226
 C/O MICHAEL MARKS
 PHONE NO. 313 962-4442

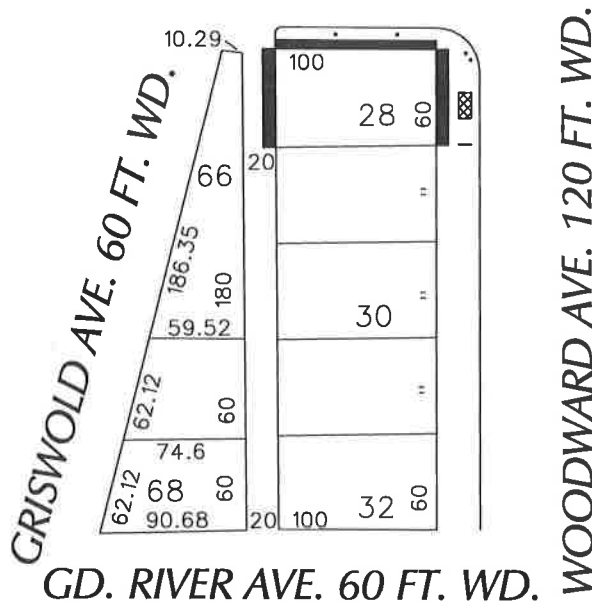

CLIFFORD AVE. 60 FT. WD.



 - REQUEST ENCROACHMENT
 (With Canopies ± 11'-8" High)

-  Light pole
-  Planter Box

CARTO 28 B

(FOR OFFICE USE ONLY)

B					
A					
DESCRIPTION		DRWN	CHKD	APPD	DATE
REVISIONS					
DRAWN BY	WLW	CHECKED			
DATE	03-21-16	APPROVED			

REQUEST ENCROACHMENT
 INTO CLIFFORD AND WOODWARD AVE.
 AND A PORTION OF THE NORTH/SOUTH
 PUBLIC ALLEY 20 FT. WD.
 AT 1449 WOODWARD AVE.
 (With Canopies)

CITY OF DETROIT CITY ENGINEERING DEPARTMENT SURVEY BUREAU	
JOB NO.	01-01
DRWG. NO.	X 1031