

15-15-68

POB-220

MATCH LINE STA. 220+00

R. P. NO.	4	STATE	PROJ. NO.		FISCAL YEAR		SHEET NO.		TOTAL SHEETS
ROUTE	4	STATE	PROJ. NO.		FISCAL YEAR		SHEET NO.		TOTAL SHEETS
ROUTE		STATE	PROJ. NO.		FISCAL YEAR		SHEET NO.		TOTAL SHEETS
ROUTE		STATE	PROJ. NO.		FISCAL YEAR		SHEET NO.		TOTAL SHEETS

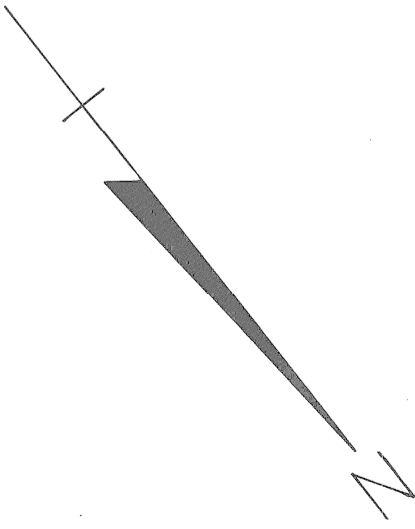

B. P. R.	STATE	PROJ. NO.	YEAR	FISCAL	SHEET	TOTAL
4	MICH.				NO.	SHEETS
ROUTE		PROJECT	COUNTY			
STATE		COUNTY		SHEET TOTAL		
ROUTE		PROJECT	COUNTY			
STATE		COUNTY		SHEET TOTAL		
B. P. R.	STATE	PROJ. NO.	YEAR	FISCAL	SHEET	TOTAL
4	MICH.				NO.	SHEETS
ROUTE		PROJECT	COUNTY			
STATE		COUNTY		SHEET TOTAL		



6-18-18
 P02 of 82122K

FREEWAY PLAN
P.O.B. TO STA. 220

MATCH LINE STA. 220+00

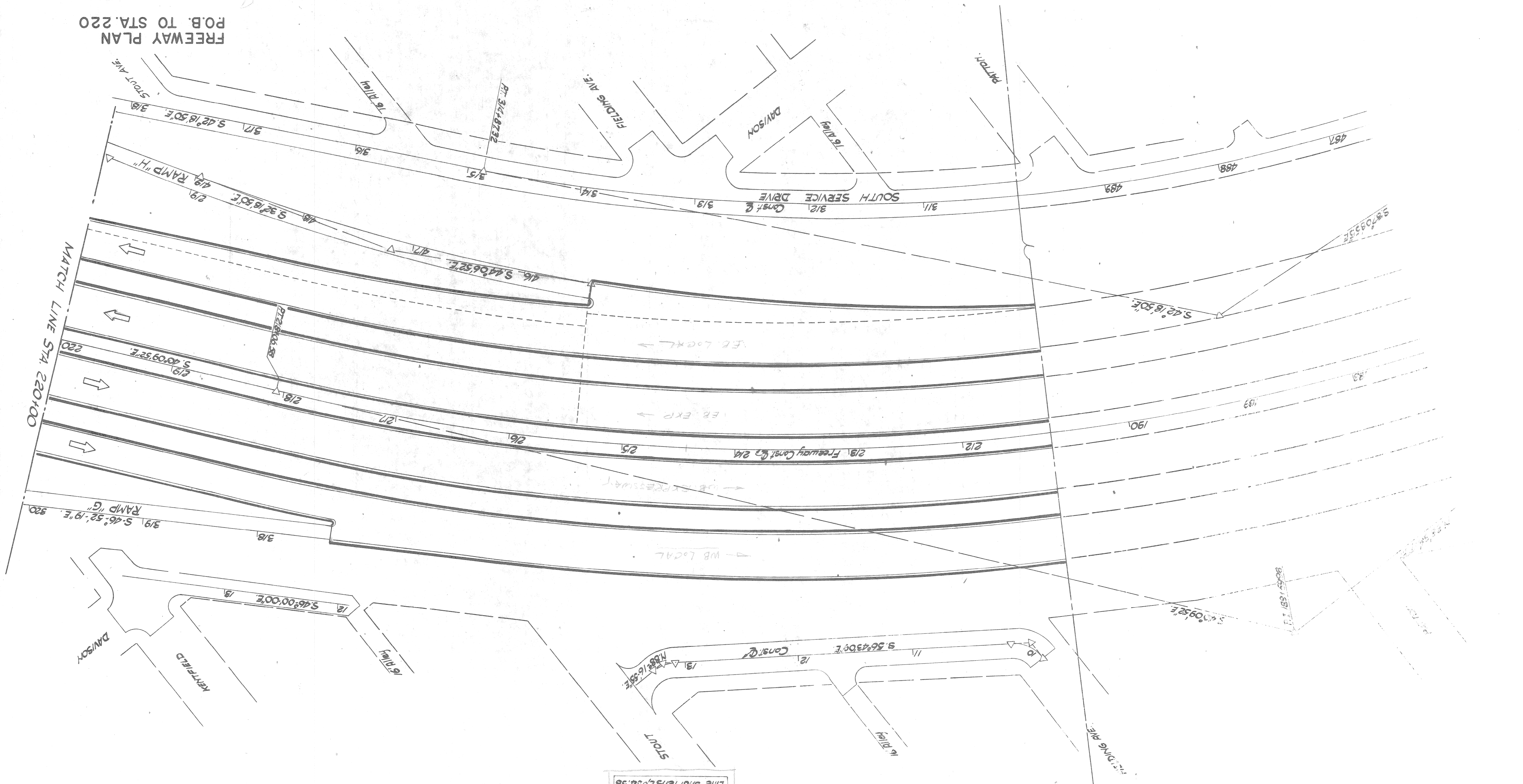

FREEWAY
Curve Data
R = 51° 13' 51" (Arc)
T = 1909.86
L = 1707.69
E = 208.17
PC = 180+44.30
PT = 189+59.98
Line Shortens 20.54, 58
Sta. Equation FREEWAY
Sta 190+68.83 Back =
Sta 211+23.41 Ahead

BM#30 Elev. 144.04
Hall, Nut & Tag
SE Root 22' Elm
Kentfield 22' Elm
W Side in front
Hec # 13517
H.W. Cor. Glendale &
Kentfield

ROUTE	STATE	PROJECT	COUNTY	SHEET NO.	TOTAL SHEETS
4	MICH.				
4	MICH.				

Squad M. Boland 68

OPERATION	BY	DATE
PRELIMINARY R.O.W. CHECKED		
FINAL DESIGN CHECKED		
FINAL E.O.W. CHECK		
QUANTITIES CHECKED		
SAVED		

DATE	BY	DESCRIPTION

Existing Profile-Median Construction & Proposed Palm Bridge

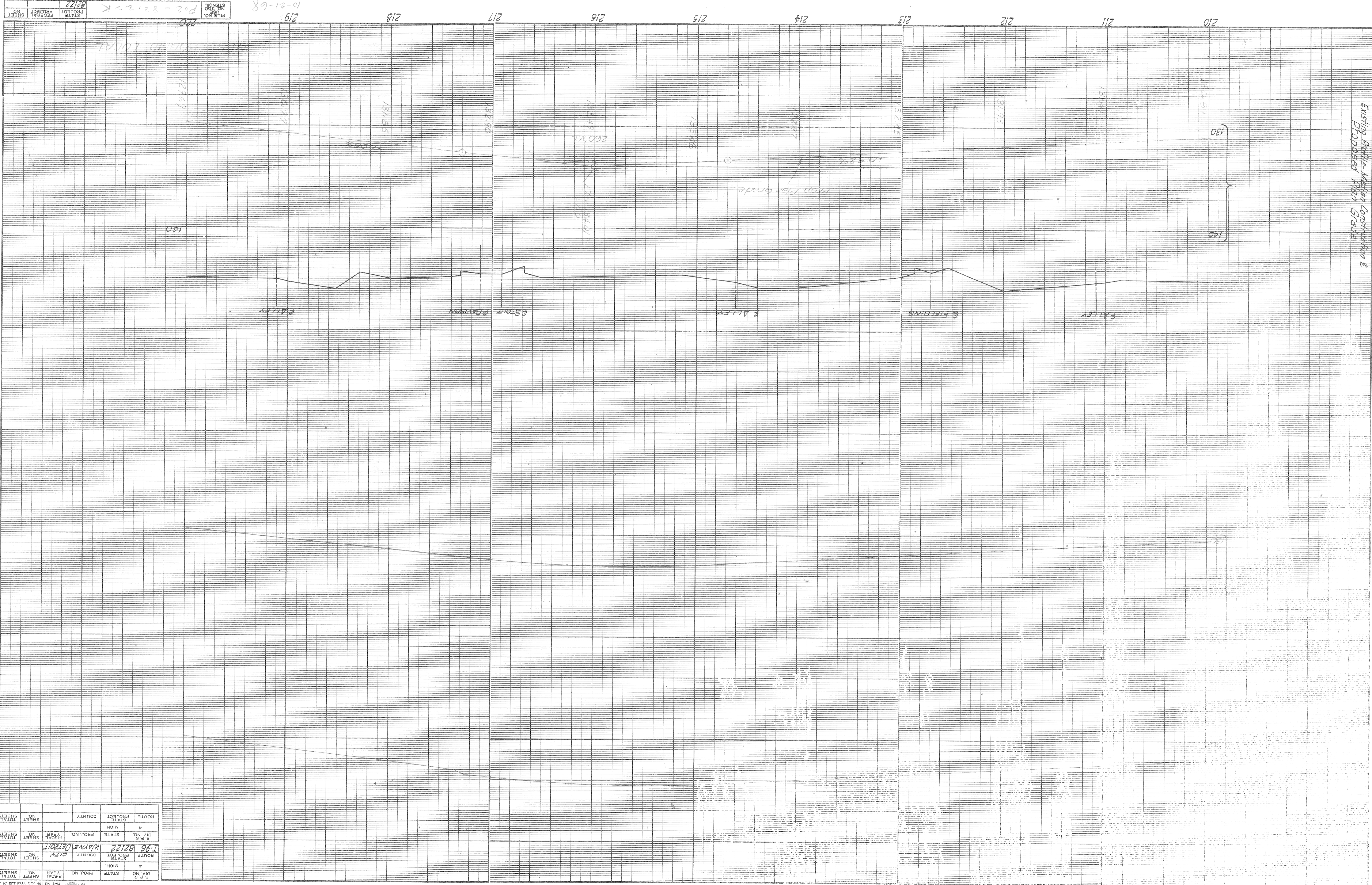

STATE	ROUTE	PROJECT	COUNTY	ROUTE PROJECT	COUNTY	SHEET NO.	TOTAL SHEETS
4	4						
1-96	82122	WAYNE	DETROIT	WAYNE	DETROIT		
4	4						
1-96	82122	WAYNE	DETROIT	WAYNE	DETROIT		

FILE NO. 10-21-68
 SR. NO. 82122
 STATE PROJECT SHEET NO. 82122

OPERATION	BY	DATE
PRELIMINARY R.O.W. CHECKED		
FINAL DESIGN CHECKED		
TRAFFIC		
FINAL R.O.W. CHECK		
QUANTITIES CHECKED		
QUANTITIES CHECKED		
SQUAD		

OPERATION	BY	DATE
SURVEYED		
FIELD		
PLAN ENDED		
PROFILE PLOTTED		
PRELIMINARY GRADE		
PRELIMINARY QUANTITIES		
FEDERAL INSPECTION		

Existing Profile-Median Construction & Proposed Plan Grade

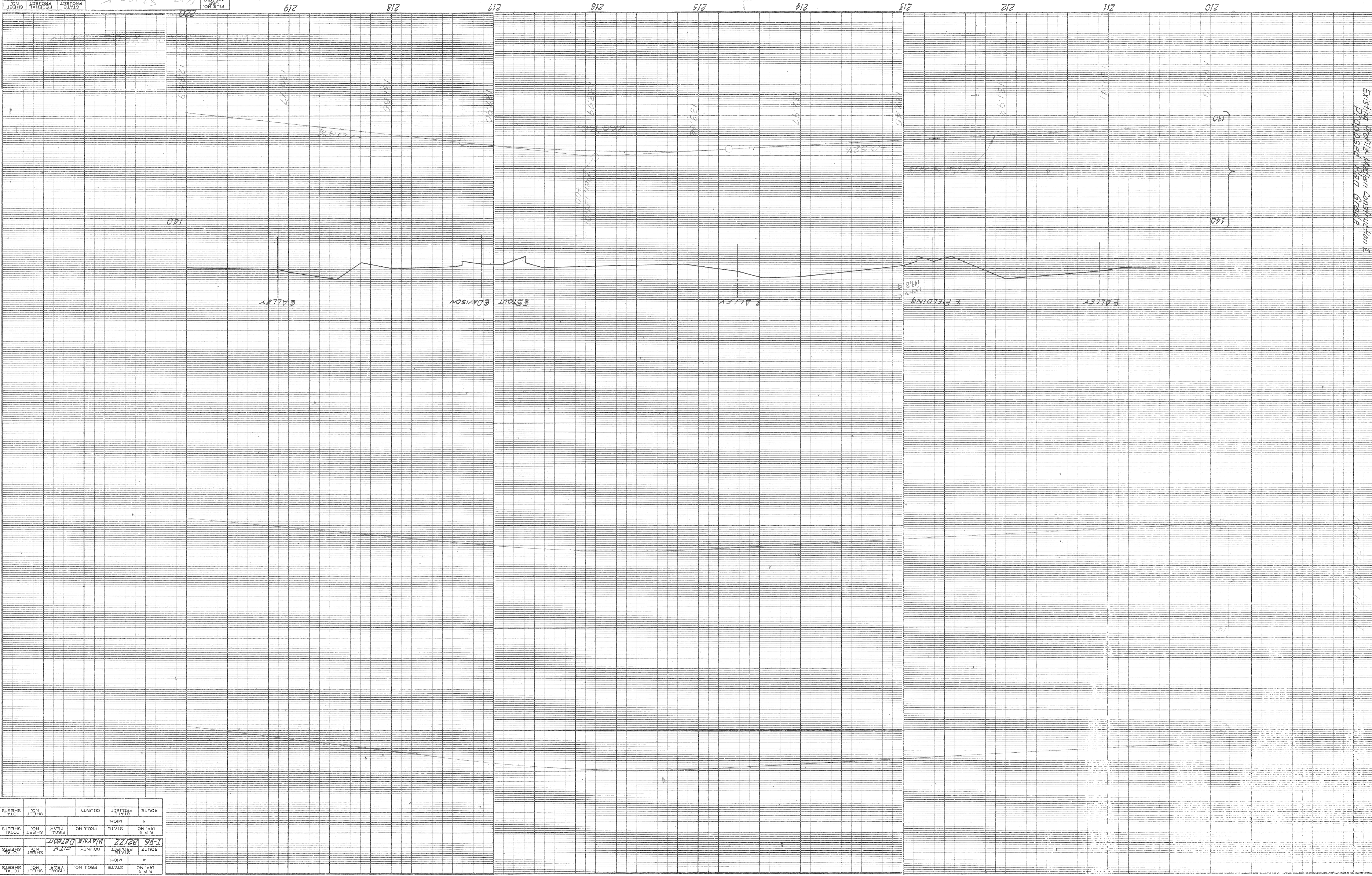

H.P. NO.	4
DIV. NO.	4
STATE	MICH.
ROUTE	1-96
COUNTY	WAYNE
CITY	DETROIT
PROJ. NO.	82122
YEAR	1966
SHEET NO.	1
TOTAL SHEETS	4

FILE NO. 82122
 PROJECT NO. 10-21-65
 SHEET NO. 1

OPERATION:	BY:	DATE:
PRELIMINARY		
FINAL DESIGN CHECKED		
TRACED		
QUANTITIES CHECKED		
SQUAD		

OPERATION:	BY:	DATE:
SURVEYED		
PLAN PLOTTED		
PROFILE PLOTTED		
PRELIMINARY GRADE		
GRADE INSPECTION		
FEDERAL INSPECTION		

EXISTING DANIEL WAGNER CORPORATION
 PROPOSED HIGH BRIDGE

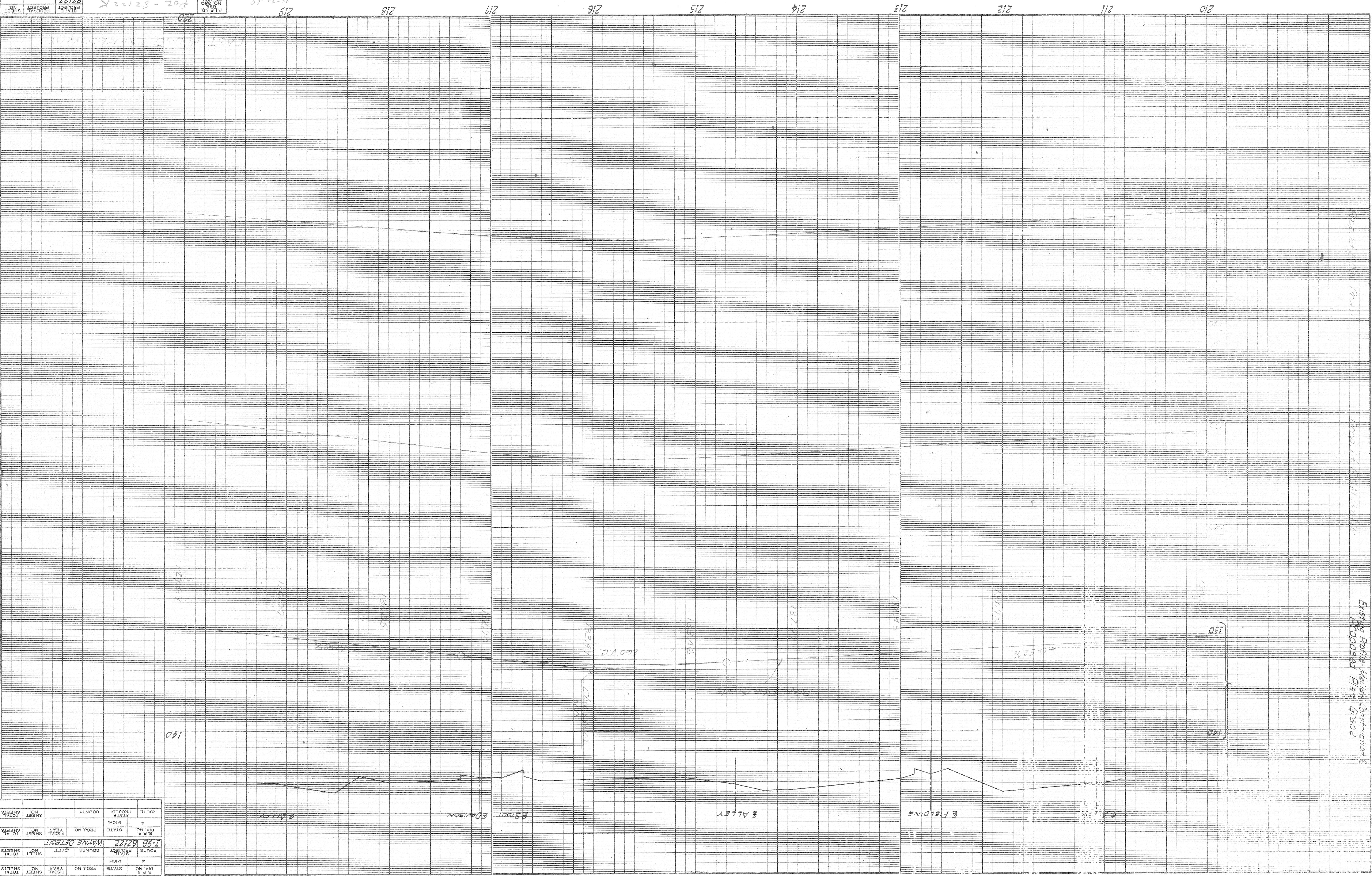

STATE	ROUTE	PROJECT	COUNTY	SHEET NO.	TOTAL SHEETS
4	4				
STATE	ROUTE	PROJECT	COUNTY	SHEET NO.	TOTAL SHEETS
4	4				
STATE	ROUTE	PROJECT	COUNTY	SHEET NO.	TOTAL SHEETS
4	4				

STATE	PROJECT	SHEET NO.	TOTAL SHEETS
4	4		

10-5-64 100 CO. TOLLIER, M. B.

OPERATION	
PRELIMINARY P.O.W. CHECKED	BY
FINAL DESIGN CHECKED	DATE
FINAL P.O.W. CHECK	
QUANTITIES CHECKED	
SQUAD	

OPERATION	
QUANTIFIED	BY
PLAN LOTTED	DATE
PROFILE & P. LOTTED	
PROFILE CHECKED	
GRADE INSPECTION	
FEDERAL INSPECTION	

Existing Profile-Median Construction & Proposed Plan Grade

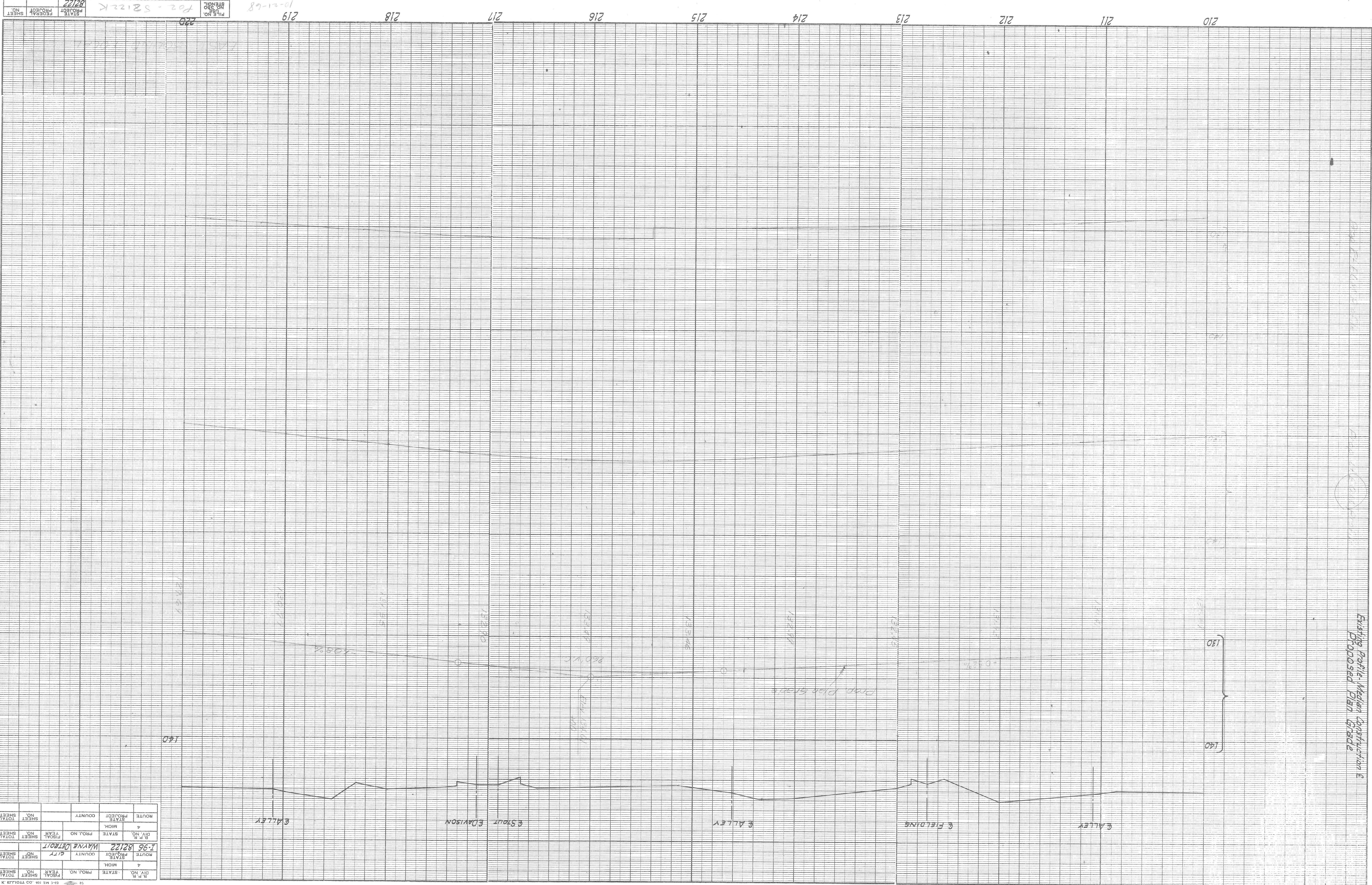

B. M.	STATE	4	ROUTE	STATE	4	ROUTE	STATE	4
PROJ. NO.	YEAR	PROJ. NO.	PROJ. NO.	PROJ. NO.	PROJ. NO.	PROJ. NO.	PROJ. NO.	PROJ. NO.
1-96	82122	1-96	82122	1-96	82122	1-96	82122	1-96
WYOMING	CITY	WYOMING	CITY	WYOMING	CITY	WYOMING	CITY	WYOMING
SHEET NO.	TOTAL SHEETS	SHEET NO.	TOTAL SHEETS	SHEET NO.	TOTAL SHEETS	SHEET NO.	TOTAL SHEETS	SHEET NO.
1	1	1	1	1	1	1	1	1

FILE NO. 89-12-68
 PROJ. NO. 102-52122K
 STATE PROJECT SHEET NO. 22122

PROJECT NO. 11-21-68
 SHEET NO. 82122K
 No Sew. Dr.-Fielding-Stout-Kentfield

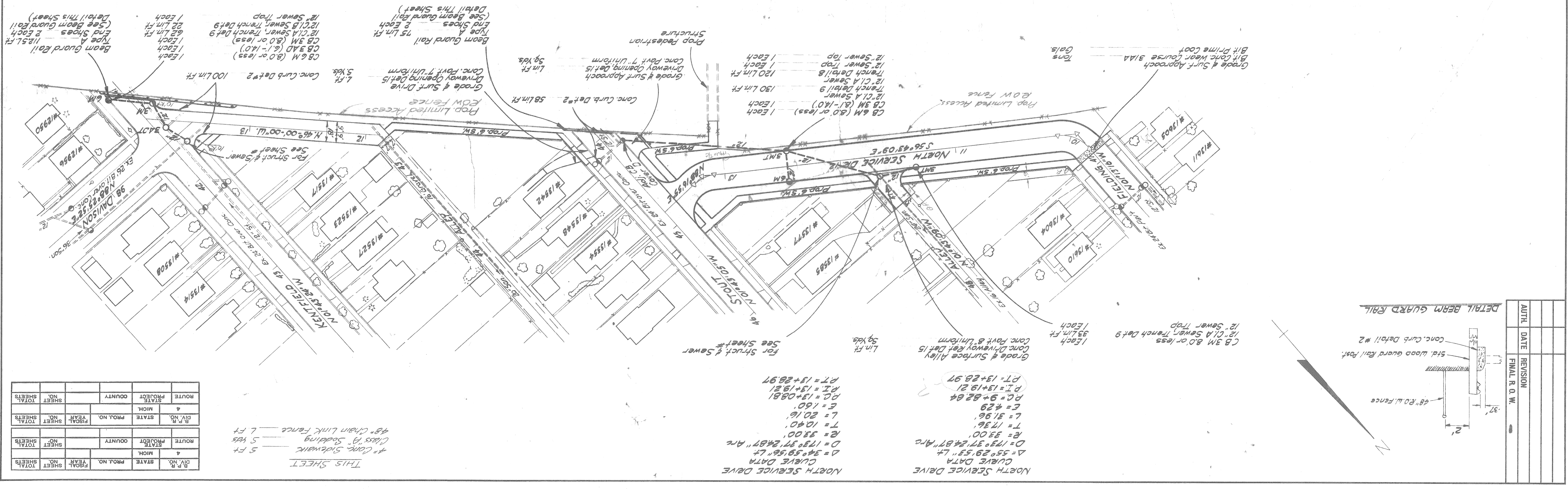
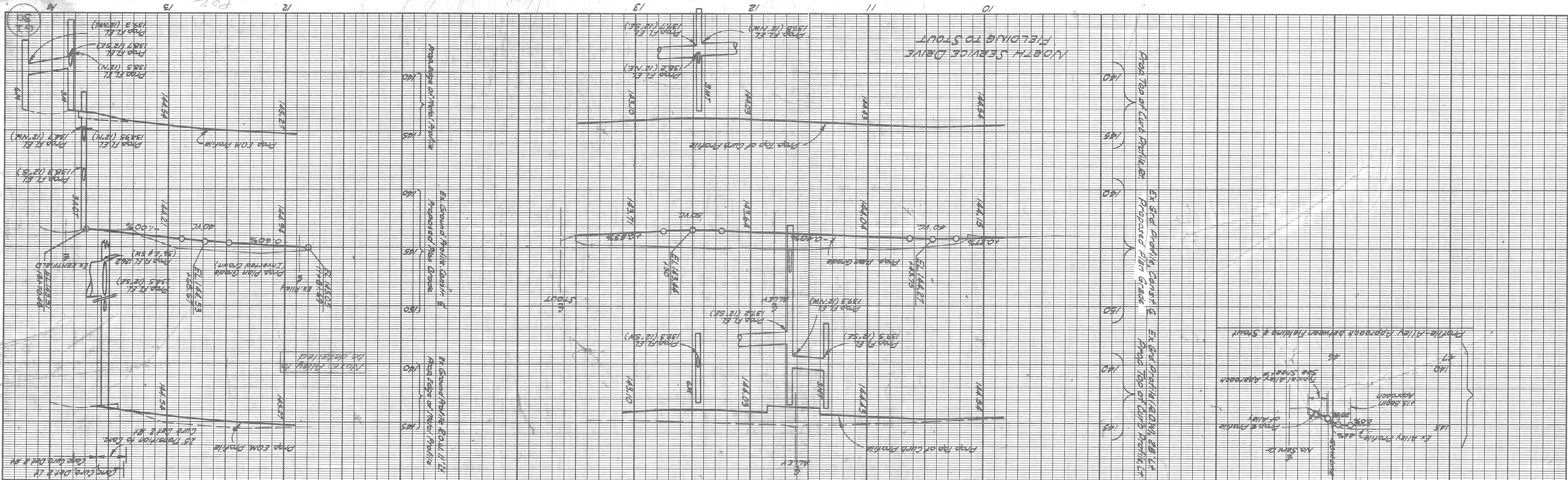

THIS SHEET

5 FT
 5 Yrs
 5 FT
 7 FT

* Conc. Sidewalk
 Class 'B' Siding
 48" Chain Link Fence

SHEET NO.	FEAR NO.	STATE	ROUTE	TOTAL SHEETS
1	1	CA	101	1
2	2	CA	101	2
3	3	CA	101	3
4	4	CA	101	4
5	5	CA	101	5
6	6	CA	101	6
7	7	CA	101	7
8	8	CA	101	8
9	9	CA	101	9
10	10	CA	101	10

CURVE DATA

North Service Drive

PT	PC	PI	T	L	E	R	D	Δ
13+13+28.97	13+13+08.81	13+19.21	17.96'	51.96'	4.29'	53.00'	173° 37' 24.87" Arc	55° 29' 53" Lt
13+13+28.97	13+13+08.81	13+19.21	12.40'	20.16'	1.60'	53.00'	173° 37' 24.87" Arc	55° 29' 53" Lt
13+13+28.97	13+13+08.81	13+19.21	10.40'	20.16'	1.60'	53.00'	173° 37' 24.87" Arc	55° 29' 53" Lt

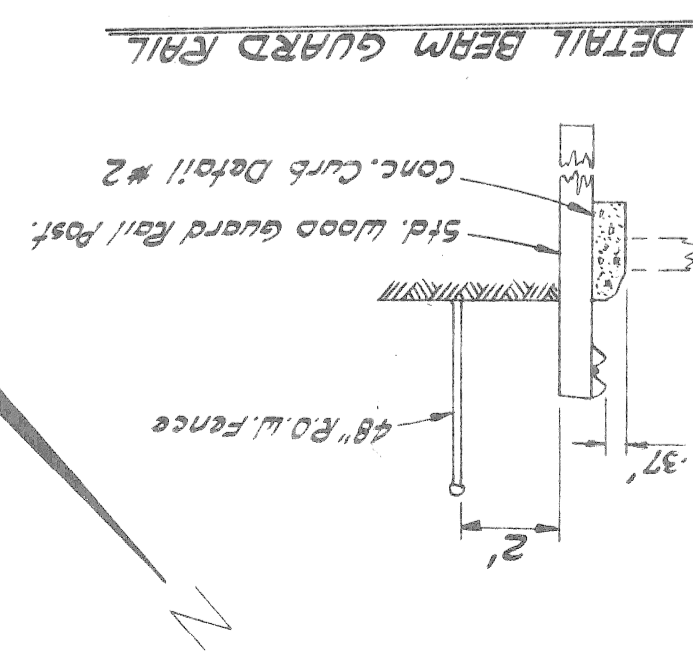

OPERATION BY DATE

SURVEYED

PLAN CHECKED

PROFILE CHECKED

PRELIMINARY GRADE

PRELIMINARY QUANTITIES CHECKED

FEDERAL INSPECTION

OPERATION BY DATE

PRELIMINARY R.O.W. CHECKED

FINAL DESIGN ORDERED

TRAFFIC DESIGN ORDERED

FINAL R.O.W. CHECK

QUANTITIES CHECKED

SOULD

AUTH.	DATE	REVISION
		FINAL R.O.W.

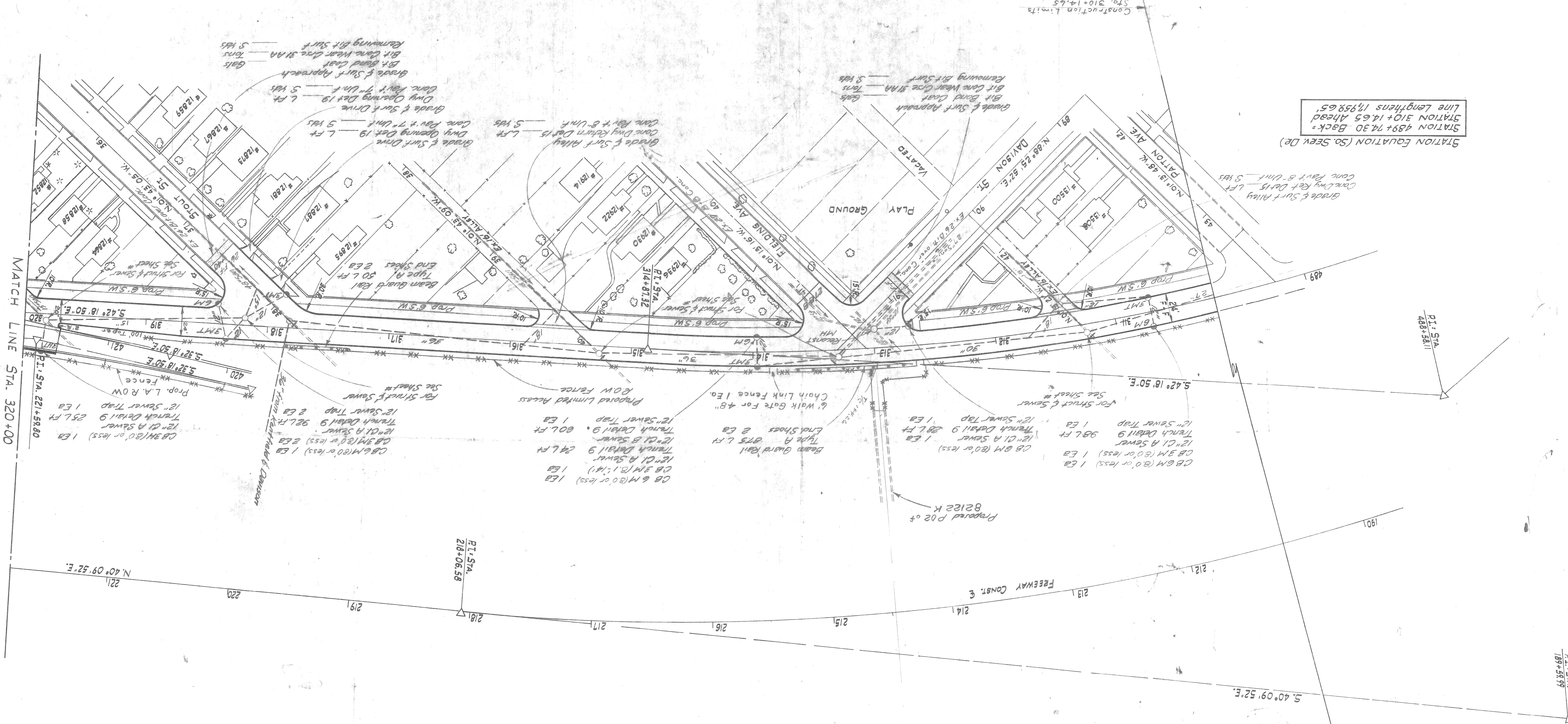

STATION EQUATION (So. Serv. Dr.)
STATION 489+74.30 Back=
STATION 310+14.65 Ahead
Line Lengthens 17959.65'

STATION EQUATION (FREEWAY)
STATION 190+68.83 Back=
STATION 211+23.41 Ahead
Line Shortens 2054.58'

SOUTH SERVICE DRIVE
CURVE DATA
D 44° 50' 05" Arc.
D 3° 36' 00" Arc.
E 1,591.54'
T 656.55'
L 1,245.41'
E 130.10'
PC 482+01.56 Back=302+41.91 Ahead
PI 488+58.11 Back=308+98.46 Ahead
PT 514+87.32 Ahead

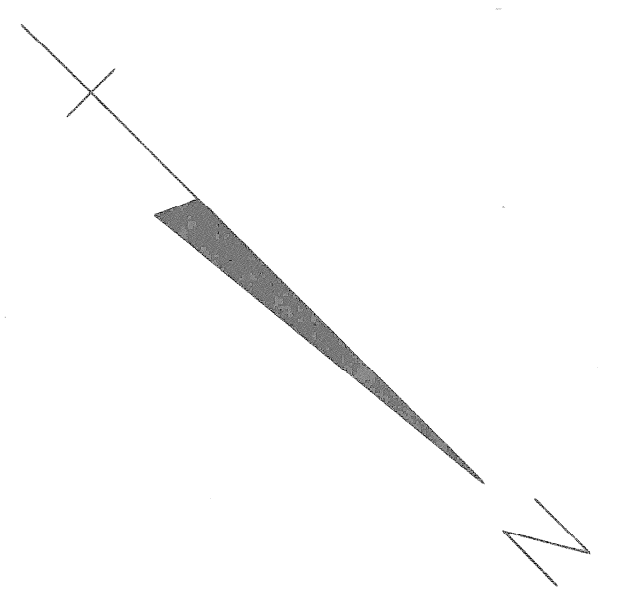

THIS SHEET
4" Conc. Sidewalk
Class A Soding
48" Chain Link Fence
Beam Guard Rail - Type A
End Shoes

B.P. NO.		STATE		PROJ. NO.		YEAR		SHEET NO.		SHEET TOTALS	
4											
MICH. CITY											
I-96 82122K Wayne Detail											
B.P. NO.		STATE		PROJ. NO.		YEAR		SHEET NO.		SHEET TOTALS	
4											
MICH. COUNTY											
ROUTE PROJECT											
SHEET TOTALS											

OPERATION	BY	DATE
PRELIMINARY		
FINAL DESIGN CHECKED		
TRAFFIC		
PROF. & V. CHECK		
QUANTITIES CHECKED		
SOUND		

OPERATION	BY	DATE
SURVEYED		
PLAN PLOTTED		
PROF. PLOTTED		
PROFILE CHECKED		
PRELIMINARY GRADE		
PREP. INSPECTION		
FINAL INSPECTION		

FILE NO. 10-21-68 318
 SHEET NO. 27
 PROJECT STATE PROJECT SHEET NO. K

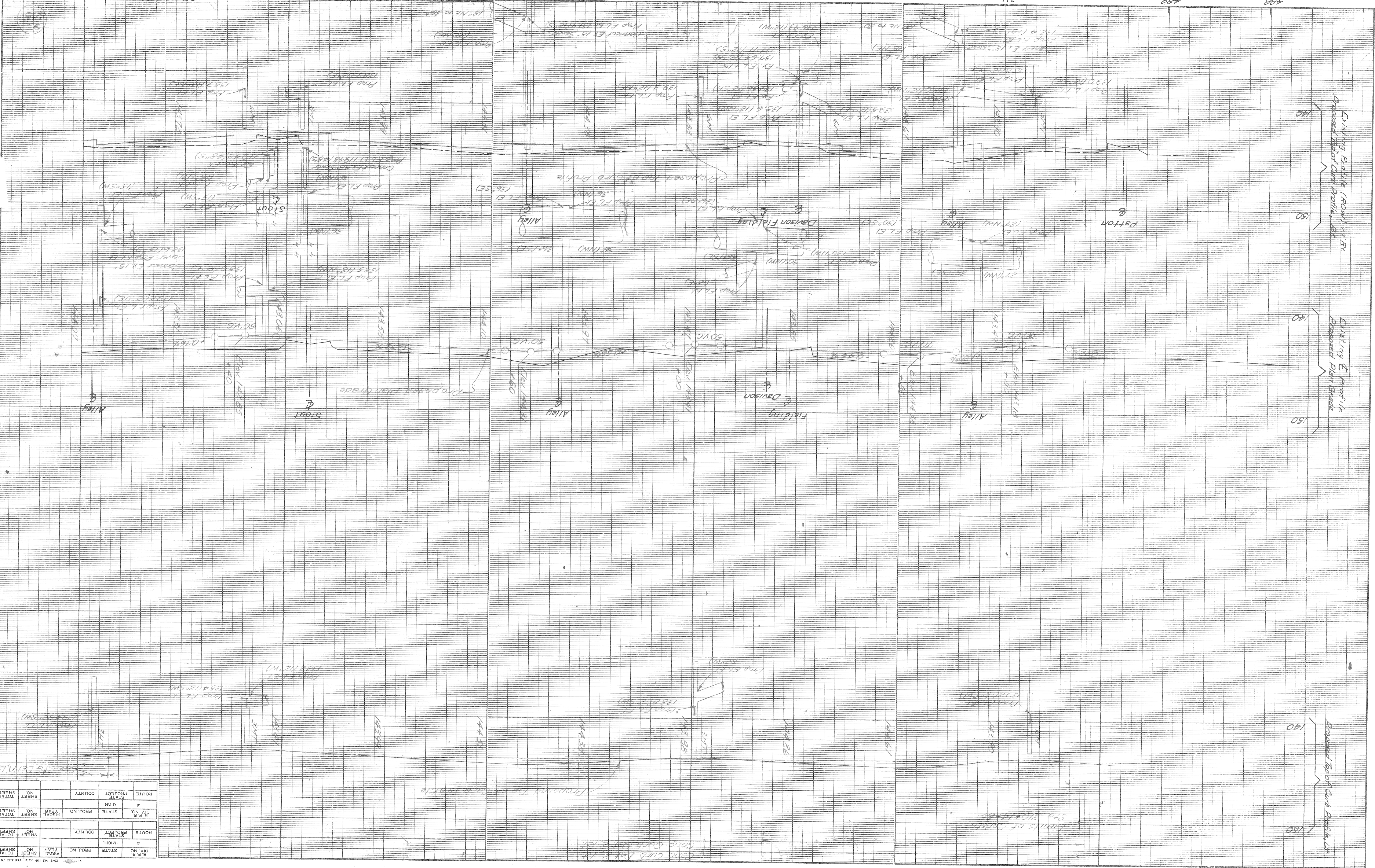

ROUTE PROJECT	COUNTY		
STATE PROJECT	MICH.	4	
DIV. NO. STATE	PROJ. NO.	YEAR	
ROUTE PROJECT	COUNTY		
STATE PROJECT	MICH.	4	
DIV. NO. STATE	PROJ. NO.	YEAR	
ROUTE PROJECT	COUNTY		
STATE PROJECT	MICH.	4	
DIV. NO. STATE	PROJ. NO.	YEAR	