



**Corporate Headquarters**  
Lansing, Michigan  
3340 Ranger Road, Lansing, MI 48906  
f: 877.884.6775  
t: 517.321.3331

**Michigan Locations**  
Berkley      Bay City  
Grand Rapids      Lansing  
Chesterfield      Oak Park

September 2019

City of Detroit  
Department of Public Works  
Coleman A. Young Municipal Building  
2 Woodward Avenue, Suite 513  
Detroit, Michigan 48226

**RE: CVS Property**  
**Located at 13580 Grand River Avenue, Detroit, Michigan**  
**Parcel ID: 22008390-5**  
**PM Environmental, Inc. Project No. 01-11327-0-0002**

To Whom it May Concern,

On behalf of 122-124 Ludlow, LLC, PM Environmental, Inc. (PM), is providing written notice to easement holders and public utilities that serve the above-referenced property to satisfy the reporting requirements in accordance with Rule 1013 of Section 20107a of Part 201 and Section 21304c of Part 213 of the Natural Resources and Environmental Protection Act (NREPA), P.A. 451 of 1994 (Part 201), as amended

Analytical results from previous site investigations completed in 1999 identified soil contamination above the Light Non-Aqueous Phase Liquid (LNAPL) Direct Contact (DC) and Soil Volatilization to Indoor Air Inhalation (SVII) screening levels. However, no soil contamination was identified during the current site investigation above the most restrictive Part 201/213 Residential SVII cleanup criteria/Risk Based Screening Levels (RBSLs) or LNAPL SVII screening levels. Additionally, no soil gas contamination was identified during the current site investigation above the Nonresidential RIASLs and EPA Commercial VISLs or at concentrations indicative of vapor intrusion conditions. Additional compounds were identified that exceed the most restrictive Part 201 cleanup criteria, but are not a dermal or inhalation human health hazard. Aside from the identified locations, additional areas may be present with elevated contaminant concentrations.

All contractors who may work sub-grade on the subject site, including excavation contractors and utility employees, are advised to take appropriate safety precautions when working on the property. 40-Hour hazardous materials safety training, personal protection equipment, and site safety plans may be necessary if working subsurface at the subject site. Soil or groundwater must be characterized prior to movement on the subject property or prior to removal from the subject property. Additional documentation concerning the existing subsurface contamination is available upon request.

Please contact us at (248) 336-9988 if you have any questions or require any additional information.

Sincerely,  
PM Environmental, Inc.

  
Tonia Hack  
Staff Geologist

Enclosure

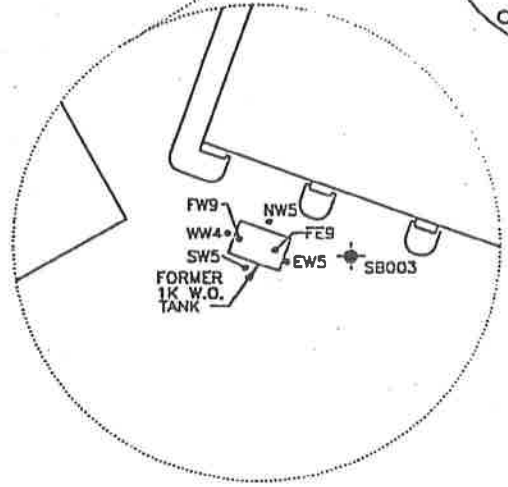
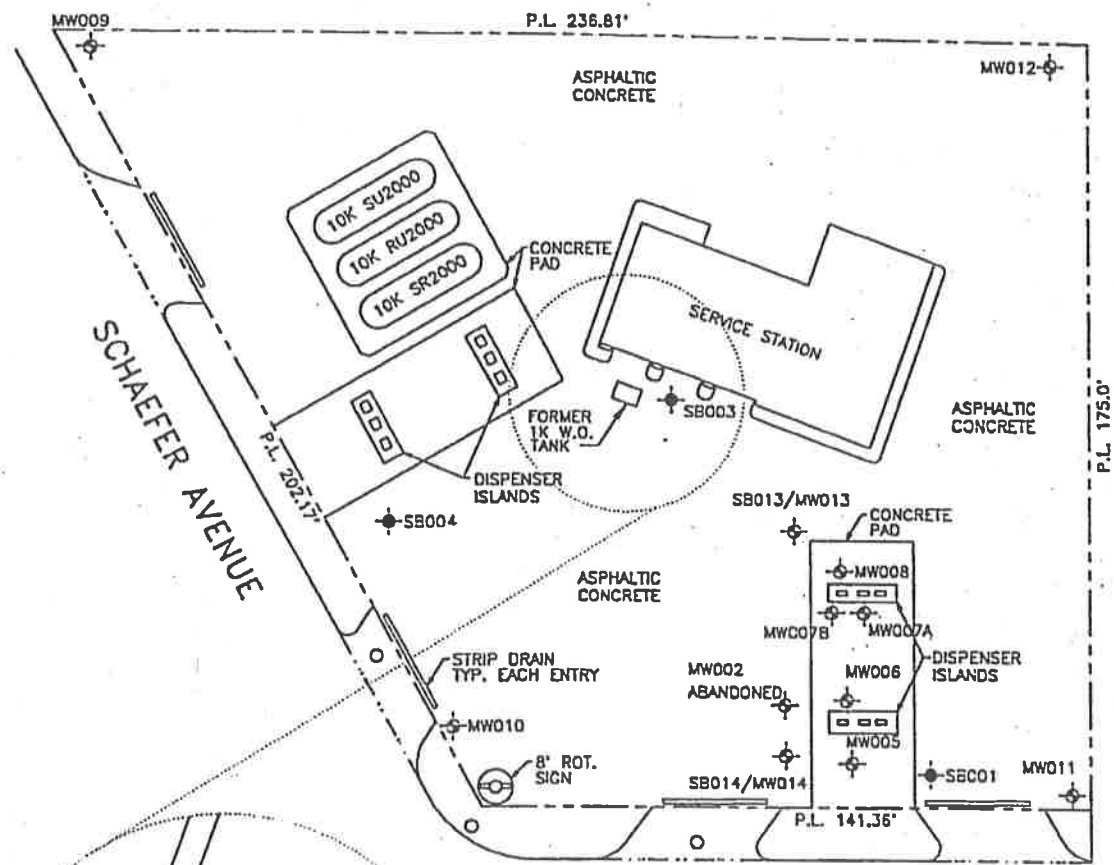
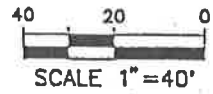

GRAND RIVER AVENUE

**EXPLANATION**

- ⊕ MONITORING WELL
- ⊙ SOIL BORING
- SAMPLE POINT

**SITE PLAN**  
**SHELL SERVICE STATION**  
 13580 GRAND RIVER AVENUE  
 AND SCHAEFER HIGHWAY  
 DETROIT, MICHIGAN

*Cor*

ATTACHMENT NO. 7

SOIL VERIFICATION SAMPLING RESULTS (LABORATORY)

FACILITY NAME Shell Service Station, 13580 Grand River

FACILITY NUMBER 221-2491-7703

VOLATILES		WW4	NW5	SW5	FE9	FW9
Sample ID						
Sample Depth (feet BGS)		4	5	5	9	9
Date Collected		1/08/97	1/08/97	1/08/97	1/08/97	1/08/97
Date Extracted		1/13/97	1/10/97	1/13/97	1/14/97	1/13/97
Date Analyzed		1/13/97	1/10/97	1/13/97	1/14/97	1/13/97
Analytical Method No.		8020A	8020A	8020A	8020A	8020A
Collection Method*		GRAB	GRAB	GRAB	GRAB	GRAB
CONSTITUENT (ug/kg)		Conc	MDL	Conc	MDL	Conc
<input checked="" type="checkbox"/> Benzene		<5	5	<5	5	10
<input checked="" type="checkbox"/> Toluene		<5	5	<5	5	<5
<input checked="" type="checkbox"/> Ethylbenzene		<5	5	6	5	<5
<input checked="" type="checkbox"/> Total Xylenes		<5	5	43	5	23
<input checked="" type="checkbox"/> MTBE		<5	5	<5	5	<5
POLYNUCLEAR AROMATICS (PNA)						
Sample ID		WW4	NW5	SW5	FE9	FW9
Sample Depth (feet BGS)		4	5	5	9	9
Date Collected		1/08/97	1/08/97	1/08/97	1/08/97	1/08/97
Date Extracted		1/14/97	1/14/97	1/14/97	1/14/97	1/14/97
Date Analyzed		1/17/97	1/18/97	1/18/97	1/18/97	1/18/97
Analytical Method No.		8310	8310	8310	8310	8310
Collection Method*		GRAB	GRAB	GRAB	GRAB	GRAB
CONSTITUENT (ug/kg)		Conc	MDL	Conc	MDL	Conc
<input checked="" type="checkbox"/> Acenaphthene		<230	230	<230	230	<230
<input checked="" type="checkbox"/> Acenaphthylene		<230	230	<230	230	<230
<input checked="" type="checkbox"/> Anthracene		<230	230	<230	230	<230
<input checked="" type="checkbox"/> Benzo(a)anthracene		<230	230	<230	230	<230
<input checked="" type="checkbox"/> Benzo(a)pyrene		<230	230	<230	230	<230
<input checked="" type="checkbox"/> Benzo(b)fluoranthene		<230	230	<230	230	<230
<input checked="" type="checkbox"/> Benzo(g,h,i)perylene		<230	230	<230	230	<230
<input checked="" type="checkbox"/> Benzo(k)fluoranthene		<230	230	<230	230	<230

Table Copy

CLOSURE ASSESSMENT REPORT (Continued)

ATTACHMENT NO. 7 (CONTINUED) PAGE 2 OF 4

SOIL VERIFICATION SAMPLING RESULTS (LABORATORY)

FACILITY NAME Shell Service Station, 13580 Grand River

FACILITY NUMBER 221-2491-7703

POLYNUCLEAR AROMATICS (PNA's)											
Sample ID	WW4	NW5	SW5	FE9	FW9						
Sample Depth (feet BGS)	4	5	5	9	9						
Date Collected	1/08/97	1/08/97	1/08/97	1/08/97	1/08/97						
Date Extracted	1/14/97	1/14/97	1/14/97	1/14/97	1/14/97						
Date Analyzed	1/17/97	1/18/97	1/18/97	1/18/97	1/18/97						
Analytical Method No.	8310	8310	8310	8310	8310						
Collection Method*	GRAB	GRAB	GRAB	GRAB	GRAB						
CONSTITUENT (ug/kg)	Conc	MDL	Conc	MDL	Conc	MDL	Conc	MDL	Conc	MDL	
<input checked="" type="checkbox"/> Chrysene	<230	230	<240	240	<230	230	<240	240	<230	230	
<input checked="" type="checkbox"/> Dibenzo(a,h)anthracene	<230	230	<240	240	<230	230	<240	240	<230	230	
<input checked="" type="checkbox"/> Fluoranthene	<230	230	<240	240	<230	230	<240	240	<230	230	
<input checked="" type="checkbox"/> Fluorene	<230	230	<240	240	<230	230	<240	240	<230	230	
<input checked="" type="checkbox"/> Indeno(1,2,3-cd)pyrene	<230	230	<240	240	<230	230	<240	240	<230	230	
<input checked="" type="checkbox"/> Naphthalene	<230	230	<240	240	<230	230	<240	240	<230	230	
<input checked="" type="checkbox"/> Phenanthrene	<230	230	<240	240	<230	230	<240	240	<230	230	
<input checked="" type="checkbox"/> Pyrene	<230	230	<240	240	<230	230	<240	240	<230	230	
<b>METALS</b>											
Sample ID	WW4	NW5	SW5	FE9	FW9						
Sample Depth (feet BGS)	4	5	5	9	9						
Date Collected	1/08/97	1/08/97	1/08/97	1/08/97	1/08/97						
Date Extracted	--	--	--	--	--						
Date Analyzed	1/15/97	1/15/97, 1/22/97, 1/15/97	1/15/97, 1/22/97, 1/15/97	1/15/97	3/24/97						
Analytical Method No.	7131A, 7191, 7421	7131A, 7191, 7421	7131A, 7191, 7421	7131A, 7191, 7421	7131A, 7191, 7421						
Collection Method*	GRAB	GRAB	GRAB	GRAB	GRAB						
CONSTITUENT (ug/kg)	Conc	MDL	Conc	MDL	Conc	MDL	Conc	MDL	Conc	MDL	
<input checked="" type="checkbox"/> Cadmium	40	20	150	20	90	20	100	20	790	20	
<input checked="" type="checkbox"/> Chromium III	29,100	1,160	21,500	1,190	19,600	1,150	16,100	480	17,200	1,140	
<input checked="" type="checkbox"/> Chromium VI	--	--	--	--	--	--	--	--	--	--	
<input checked="" type="checkbox"/> Total Lead	9,060	120	7,510	120	11,700	230	8,400	120	19,900	1,140	

CLOSURE ASSESSMENT REPORT (Continued)

ATTACHMENT NO. 7 (CONTINUED) PAGE 3 OF 4

SOIL VERIFICATION SAMPLING RESULTS (LABORATORY)

FACILITY NAME Shell Service Station, 13580 Grand River

FACILITY NUMBER 221-2491-7703

PCBs											
Sample ID	WW4	NW5	SW5	FE9	FW9						
Sample Depth (feet BGS)	4	5	5	9	9						
Date Collected	1/08/97	1/08/97	1/08/97	1/08/97	1/08/97						
Date Extracted	1/16/97	1/16/97	1/16/97	1/16/97	1/16/97						
Date Analyzed	1/23/97	1/23/97	1/23/97	1/23/97	1/23/97						
Analytical Method No.	8080	8080	8080	8080	8080						
Collection Method*	GRAB	GRAB	GRAB	GRAB	GRAB						
CONSTITUENT (ug/kg)	Conc	MDL	Conc	MDL	Conc	MDL	Conc	MDL	Conc	MDL	
<input checked="" type="checkbox"/> Aroclor 1016	<230	230	<240	240	<230	230	<240	240	<230	230	
<input checked="" type="checkbox"/> Aroclor 1221	<230	230	<240	240	<230	230	<240	240	<230	230	
<input checked="" type="checkbox"/> Aroclor 1232	<230	230	<240	240	<230	230	<240	240	<230	230	
<input checked="" type="checkbox"/> Aroclor 1242	<230	230	<240	240	<230	230	<240	240	<230	230	
<input checked="" type="checkbox"/> Aroclor 1248	<230	230	<240	240	<230	230	<240	240	<230	230	
<input checked="" type="checkbox"/> Aroclor 1254	<230	230	<240	240	<230	230	<240	240	<230	230	
<input checked="" type="checkbox"/> Aroclor 1260	<230	230	<240	240	<230	230	<240	240	<230	230	
HALOGENATED HYDROCARBONS											
Sample ID	WW4	NW5	SW5	FE9	FW9						
Sample Depth (feet BGS)	4	5	5	9	9						
Date Collected	1/08/97	1/08/97	1/08/97	1/08/97	1/08/97						
Date Extracted	1/13/97	1/13/97	1/13/97	1/13/97	1/13/97						
Date Analyzed	1/13/97	1/13/97	1/13/97	1/13/97	1/13/97						
Analytical Method No.	8010	8010	8010	8010	8010						
Collection Method*	GRAB	GRAB	GRAB	GRAB	GRAB						
CONSTITUENT (ug/kg)	Conc	MDL	Conc	MDL	Conc	MDL	Conc	MDL	Conc	MDL	
<input checked="" type="checkbox"/> Carbon Tetrachloride	<1.0	1.0	<1.0	1.0	<1.0	1.0	<1.0	1.0	<1.0	1.0	
<input checked="" type="checkbox"/> 1,1-Dichloroethane	<2.0	2.0	<2.0	2.0	<2.0	2.0	<2.0	2.0	<2.0	2.0	
<input checked="" type="checkbox"/> 1,2-Dichloroethane	<1.0	1.0	<1.0	1.0	<1.0	1.0	<1.0	1.0	<1.0	1.0	
<input checked="" type="checkbox"/> 1,1-Dichloroethene	<2.0	2.0	<2.0	2.0	<2.0	2.0	<2.0	2.0	<2.0	2.0	

CLOSURE ASSESSMENT REPORT (Continued)

ATTACHMENT NO. 7 (CONTINUED) PAGE 4 OF 4

SOIL VERIFICATION SAMPLING RESULTS (LABORATORY)

FACILITY NAME Shell Service Station, 13580 Grand River

FACILITY NUMBER 221-2491-7703

HALOGENATED HYDROCARBONS	WW4		NW5		SW5		FE9		FW9	
	Sample ID	4	5	5	5	9	9	9	9	
Sample Depth (feet BGS)										
Date Collected	1/08/97	1/08/97	1/08/97	1/08/97	1/08/97	1/08/97	1/08/97	1/08/97	1/08/97	
Date Extracted	1/13/97	1/13/97	1/13/97	1/13/97	1/13/97	1/13/97	1/13/97	1/13/97	1/13/97	
Date Analyzed	1/13/97	1/13/97	1/13/97	1/13/97	1/13/97	1/13/97	1/13/97	1/13/97	1/13/97	
Analytical Method No.	8010	8010	8010	8010	8010	8010	8010	8010	8010	
Collection Method*	GRAB	GRAB	GRAB	GRAB	GRAB	GRAB	GRAB	GRAB	GRAB	
CONSTITUENT (ug/kg)	Conc	MDL	Conc	MDL	Conc	MDL	Conc	MDL	Conc	MDL
<input type="checkbox"/> cis-1,2-Dichloroethylene	--	--	--	--	--	--	--	--	--	--
<input checked="" type="checkbox"/> trans-1,2-Dichloroethene	<2.0	2.0	<2.0	2.0	<2.0	2.0	<2.0	2.0	<2.0	2.0
<input checked="" type="checkbox"/> Tetrachloroethene	<2.0	2.0	<2.0	2.0	<2.0	2.0	<2.0	2.0	<2.0	2.0
<input checked="" type="checkbox"/> 1,1,2-Trichloroethane	<2.0	2.0	<2.0	2.0	<2.0	2.0	<2.0	2.0	<2.0	2.0
OTHER (Specify)										
Sample ID										
Sample Depth (feet BGS)										
Date Collected										
Date Extracted										
Date Analyzed										
Analytical Method No.										
Collection Method*										
CONSTITUENT (ug/kg)	Conc	MDL	Conc	MDL	Conc	MDL	Conc	MDL	Conc	MDL
<input type="checkbox"/>										
<input type="checkbox"/>										
<input type="checkbox"/>										
<input type="checkbox"/>										
<input type="checkbox"/>										
<input type="checkbox"/>										



ATTACHMENT NO. 7  
 SOIL VERIFICATION SAMPLING RESULTS (LABORATORY)  
 FACILITY NAME Shell Service Station, 13580 Grand River  
 FACILITY NUMBER 221-2491-7703

VOLATILES									
Sample ID	EW5	Sample Depth (feet BGS)	5	Date Collected	1/08/97	Date Extracted	1/11/97	Date Analyzed	1/11/97
Analytical Method No.	8020A	Collection Method*	GRAB	Conc	MDL	Conc	MDL	Conc	MDL
CONSTITUENT (ug/kg)									
<input checked="" type="checkbox"/> Benzene	8	<5	5						
<input checked="" type="checkbox"/> Toluene	<5	6	5						
<input checked="" type="checkbox"/> Ethylbenzene	6	>5	5						
<input checked="" type="checkbox"/> Total Xylenes	>5	<5	5						
<input checked="" type="checkbox"/> MTBE	<5		5						
POLYNUCLEAR AROMATICS (PNAs)									
Sample ID	EW5	Sample Depth (feet BGS)	5	Date Collected	1/08/97	Date Extracted	1/14/97	Date Analyzed	1/18/97
Analytical Method No.	8310	Collection Method*	GRAB	Conc	MDL	Conc	MDL	Conc	MDL
CONSTITUENT (ug/kg)									
<input checked="" type="checkbox"/> Acenaphthene	<230	<230	230						
<input checked="" type="checkbox"/> Anthracene	<230	<230	230						
<input checked="" type="checkbox"/> Benzo(a)anthracene	<230	<230	230						
<input checked="" type="checkbox"/> Benzo(a)pyrene	<230	<230	230						
<input checked="" type="checkbox"/> Benzo(b)fluoranthene	<230	<230	230						
<input checked="" type="checkbox"/> Benzo(k)fluoranthene	<230	<230	230						

**ATTACHMENT NO. 7 (CONTINUED) PAGE 2 OF 4  
SOIL VERIFICATION SAMPLING RESULTS (LABORATORY)  
FACILITY NAME Shell Service Station, 13580 Grand River  
FACILITY NUMBER 221-2491-7703**

POLYNUCLEAR AROMATICS (PNAs)		EW5							
Sample ID		Conc	MDL	Conc	MDL	Conc	MDL	Conc	MDL
Sample Depth (feet BGS)	5								
Date Collected	1/08/97								
Date Extracted	1/14/97								
Date Analyzed	1/18/97								
Analytical Method No.	8310								
Collection Method*	GRAB								
CONSTITUENT (ug/kg)	Conc	MDL	Conc	MDL	Conc	MDL	Conc	MDL	MDL
<input checked="" type="checkbox"/> Chrysene	<230	230							
<input checked="" type="checkbox"/> Dibenzo(a,h)anthracene	<230	230							
<input checked="" type="checkbox"/> Fluoranthene	<230	230							
<input checked="" type="checkbox"/> Fluorene	<230	230							
<input checked="" type="checkbox"/> Indeno(1,2,3-cd)pyrene	<230	230							
<input checked="" type="checkbox"/> Naphthalene	<230	230							
<input checked="" type="checkbox"/> Pyrene	<230	230							
<b>METALS</b>									
Sample ID	EW5								
Sample Depth (feet BGS)	5								
Date Collected	1/08/97								
Date Extracted	--								
Date Analyzed	1/15/97								
Analytical Method No.	7131A, 7191, 7421								
Collection Method*	GRAB								
CONSTITUENT (ug/kg)	Conc	MDL	Conc	MDL	Conc	MDL	Conc	MDL	MDL
<input checked="" type="checkbox"/> Cadmium	90	20							
<input checked="" type="checkbox"/> Chromium III	17,100	570							
<input checked="" type="checkbox"/> Chromium VI	--	--							
<input checked="" type="checkbox"/> Total Lead	6,950	110							

BGS = Below Ground Surface

\* Collection Method Codes (List all that apply): Grab Sample (GS), Split Spoon (SS), Hand Auger (HA), Geoprobe (GP), Continuous Corer (CC), Soil Gas (SG), Cone Penetrometer (CP), Hydropunch (HP)

If Other (OT), specify here:

MDL = Method Detection Limit

DT 97-46 GRAND RIVER/SCHAFFER/CLTABLE.DOC



ATTACHMENT NO. 7 (CONTINUED) PAGE 3 OF 4  
 SOIL VERIFICATION SAMPLING RESULTS (LABORATORY)  
 FACILITY NAME Shell Service Station, 13580 Grand River  
 FACILITY NUMBER 221-2491-7703

PCBs		EWS							
Sample ID	EW5	Conc	MDL	Conc	MDL	Conc	MDL	Conc	MDL
Sample Depth (feet BGS)	5								
Date Collected	1/08/97								
Date Extracted	1/16/97								
Date Analyzed	1/23/97								
Analytical Method No.	8080								
Collection Method*	GRAB								
CONSTITUENT (ug/kg)	Conc	MDL	Conc	MDL	Conc	MDL	Conc	MDL	MDL
<input checked="" type="checkbox"/> Aroclor 1016	<230	230							
<input checked="" type="checkbox"/> Aroclor 1221	<230	230							
<input checked="" type="checkbox"/> Aroclor 1232	<230	230							
<input checked="" type="checkbox"/> Aroclor 1242	<230	230							
<input checked="" type="checkbox"/> Aroclor 1248	<230	230							
<input checked="" type="checkbox"/> Aroclor 1254	<230	230							
<input checked="" type="checkbox"/> Aroclor 1260	<230	230							
<b>HALOGENATED</b>									
<b>HYDROCARBONS</b>									
Sample ID	EW5	Conc	MDL	Conc	MDL	Conc	MDL	Conc	MDL
Sample Depth (feet BGS)	5								
Date Collected	1/08/97								
Date Extracted	1/13/97								
Date Analyzed	1/13/97								
Analytical Method No.	8010								
Collection Method*	GRAB								
CONSTITUENT (ug/kg)	Conc	MDL	Conc	MDL	Conc	MDL	Conc	MDL	MDL
<input checked="" type="checkbox"/> Carbon Tetrachloride	<1.0	1.0							
<input checked="" type="checkbox"/> 1,1-Dichloroethane	<2.0	2.0							
<input checked="" type="checkbox"/> 1,2-Dichloroethane	<1.0	1.0							
<input checked="" type="checkbox"/> 1,1-Dichloroethylene	--	--							

BGS = Below Ground Surface  
 \* Collection Method Codes (*List all that apply*): Grab Sample (GS), Split Spoon (SS), Hand Auger (HA), Geoprobe (GP), Continuous Corer (CC), Soil Gas (SG), Cone Penetrometer (CP), Hydropunch (HP)  
 If Other (OT), specify here: \_\_\_\_\_  
 MDL = Method Detection Limit  
 DT 97-46 GRAND RIVER/SCHAFFER/CLTABLE.DOC

ATTACHMENT NO. 7 (CONTINUED) PAGE 4 OF 4  
 SOIL VERIFICATION SAMPLING RESULTS (LABORATORY)  
 FACILITY NAME Shell Service Station, 13580 Grand River  
 FACILITY NUMBER 221-2491-7703

HALOGENATED HYDROCARBONS											
Sample ID	EWS										
Sample Depth (feet BGS)	5										
Date Collected	1/08/97										
Date Extracted	1/13/97										
Date Analyzed	1/13/97										
Analytical Method No.	8010										
Collection Method*	GRAB										
CONSTITUENT (ug/kg)	Conc	MDL	Conc	MDL	Conc	MDL	Conc	MDL	Conc	MDL	MDL
<input checked="" type="checkbox"/> cis-1,2-Dichloroethylene	-	-	-	-	-	-	-	-	-	-	-
<input checked="" type="checkbox"/> trans-1,2-Dichloroethylene	-	-	-	-	-	-	-	-	-	-	-
<input checked="" type="checkbox"/> Tetrachloroethylene	-	-	-	-	-	-	-	-	-	-	-
<input checked="" type="checkbox"/> 1,1,2-Trichloroethane	<2.0	2.0									
OTHER (Specify)											
Sample ID											
Sample Depth (feet BGS)											
Date Collected											
Date Extracted											
Date Analyzed											
Analytical Method No.											
Collection Method*											
CONSTITUENT (ug/kg)	Conc	MDL	Conc	MDL	Conc	MDL	Conc	MDL	Conc	MDL	MDL
<input type="checkbox"/>											
<input type="checkbox"/>											
<input type="checkbox"/>											
<input type="checkbox"/>											
<input type="checkbox"/>											
<input type="checkbox"/>											

BGS = Below Ground Surface

\* Collection Method Codes (List all that apply): Grab Sample (GS), Split Spoon (SS), Hand Auger (HA), Geoprobe (GP), Continuous Corer (CC), Soil Gas (SG), Cone Penetrometer (CP), Hydropunch (HP)

If Other (OT), specify here:

MDL = Method Detection Limit

DT 97-46 GRAND RIVER/SCHAFFER/CLOTABLE.DOC

CLOSURE ASSESSMENT REPORT (Continued)

ATTACHMENT NO. 8 (CONTINUED) PAGE 2 OF 2

COMPARISON TABLE FOR SOIL VERIFICATION

FACILITY NAME Shell Service Station, 13580 Grand River

FACILITY NUMBER 221-2491-7703

Contaminant	Number of Samples Taken	Range of Detected Concentrations [Min - Max] (ug/kg)	Maximum Detected (ug/kg)	Applicable RBSL or SSTL Criterion (Specify Tier Level in ( ))			
				Residential	Commercial III	Commercial IV	Industrial
<b>PCBs</b>							
<input checked="" type="checkbox"/> Aroclor 1016	6	<230 -- <240	240	330 ( I )	( )	( )	( )
<input checked="" type="checkbox"/> Aroclor 1221	6	<230 -- <240	240	330 ( I )	( )	( )	( )
<input checked="" type="checkbox"/> Aroclor 1232	6	<230 -- <240	240	330 ( I )	( )	( )	( )
<input checked="" type="checkbox"/> Aroclor 1242	6	<230 -- <240	240	330 ( I )	( )	( )	( )
<input checked="" type="checkbox"/> Aroclor 1248	6	<230 -- <240	240	330 ( I )	( )	( )	( )
<input checked="" type="checkbox"/> Aroclor 1254	6	<230 -- <240	240	330 ( I )	( )	( )	( )
<input checked="" type="checkbox"/> Aroclor 1260	6	<230 -- <240	240	330 ( I )	( )	( )	( )
<b>HALOGENATED HYDROCARBONS</b>							
<input checked="" type="checkbox"/> Carbon Tetrachloride	6	<1 -- <1	<1	100 ( I )	( )	( )	( )
<input checked="" type="checkbox"/> 1,1-Dichloroethane	6	<2 -- <2	<2	18,000 ( I )	( )	( )	( )
<input checked="" type="checkbox"/> 1,2-Dichloroethane	6	<1 -- <1	1	100 ( I )	( )	( )	( )
<input checked="" type="checkbox"/> 1,1-Dichloroethylene	5	<2 -- <2	<2	140 ( I )	( )	( )	( )
<input type="checkbox"/> cis-1,2-Dichloroethylene	0	--	--	( I )	( )	( )	( )
<input checked="" type="checkbox"/> trans-1,2-Dichloroethylene	5	<2 -- <2	<2	2000 ( I )	( )	( )	( )
<input checked="" type="checkbox"/> Tetrachloroethylene	5	<2 -- <2	<2	100 ( I )	( )	( )	( )
<input checked="" type="checkbox"/> 1,1,2-Trichloroethane	6	<2 -- <2	<2	100 ( I )	( )	( )	( )
<b>OTHER*</b>							
		--	--	( )	( )	( )	( )
		--	--	( )	( )	( )	( )
		--	--	( )	( )	( )	( )
		--	--	( )	( )	( )	( )
		--	--	( )	( )	( )	( )
		--	--	( )	( )	( )	( )

\*List additional contaminants as appropriate

MICHIGAN DEPARTMENT OF ENVIRONMENTAL QUALITY - UNDERGROUND STORAGE TANK DIVISION  
**CLOSURE ASSESSMENT REPORT (Continued)**

**ATTACHMENT NO. 8**  
**COMPARISON TABLE FOR SOIL VERIFICATION**  
**FACILITY NAME Shell Service Station, 13580 Grand River**  
**FACILITY NUMBER 221-2491-7703**

Contaminant	Number of Samples Taken	Range of Detected Concentrations [Min - Max] (ug/kg)	Maximum Detected (ug/kg)	Applicable RBSL or SSTL Criterion /Specify Tier Level in ( )/	
				Residential	Commercial III Commercial IV
<b>VOLATILES</b>					
<input checked="" type="checkbox"/> Benzene	6	<5 -- 10	10	100 ( I )	( ) ( )
<input checked="" type="checkbox"/> Toluene	6	<5 -- <5	<5	16,000 ( I )	( ) ( )
<input checked="" type="checkbox"/> Ethylbenzene	6	<5 -- 6	6	1500 ( I )	( ) ( )
<input checked="" type="checkbox"/> Total Xylenes	6	<5 -- 43	43	5600 ( I )	( ) ( )
<input checked="" type="checkbox"/> MTBE	6	<5 -- <5	<5	4800 ( I )	( ) ( )
<b>POLYNUCLEAR AROMATICS (PNAs)</b>					
<input checked="" type="checkbox"/> Acenaphthene	6	<230 -- <240	<240	300,000 ( I )	( ) ( )
<input checked="" type="checkbox"/> Acenaphthylene	6	<230 -- <240	<240	520 ( I )	( ) ( )
<input checked="" type="checkbox"/> Anthracene	6	<230 -- <240	<240	4.2E+8 ( I )	( ) ( )
<input checked="" type="checkbox"/> Benzo(a)anthracene	6	<230 -- <240	<240	14,000 ( I )	( ) ( )
<input checked="" type="checkbox"/> Benzo(a)pyrene	6	<230 -- <240	<240	1400 ( I )	( ) ( )
<input checked="" type="checkbox"/> Benzo(b)fluoranthene	6	<230 -- <240	<240	1.5E+6 ( I )	( ) ( )
<input checked="" type="checkbox"/> Benzo(g,h,i)perylene	6	<230 -- <240	<240	140,000 ( I )	( ) ( )
<input checked="" type="checkbox"/> Benzo(k)fluoranthene	6	<230 -- <240	<240	1.4E+6 ( I )	( ) ( )
<input checked="" type="checkbox"/> Chrysene	6	<230 -- <240	<240	( I )	( ) ( )
<input checked="" type="checkbox"/> Dibenzo(a,h)anthracene	6	<230 -- <240	<240	( I )	( ) ( )
<input checked="" type="checkbox"/> Fluoranthene	6	<230 -- <240	<240	( I )	( ) ( )
<input checked="" type="checkbox"/> Fluorene	6	<230 -- <240	<240	( I )	( ) ( )
<input checked="" type="checkbox"/> Indeno(1,2,3-cd)pyrene	6	<230 -- <240	<240	( I )	( ) ( )
<input checked="" type="checkbox"/> Naphthalene	6	<230 -- <240	<240	( I )	( ) ( )
<input checked="" type="checkbox"/> Phenanthrene	6	<230 -- <240	<240	( I )	( ) ( )
<input checked="" type="checkbox"/> Pyrene	6	<230 -- <240	<240	( )	( ) ( )
<b>METALS</b>					
<input checked="" type="checkbox"/> Cadmium	6	40 -- 790	790	6000 ( I )	( ) ( )
<input checked="" type="checkbox"/> Chromium III	6	--	--	( )	( ) ( )
<input checked="" type="checkbox"/> Total Chromium	6	16,100 -- 29,100	29,100	31,000 ( I )	( ) ( )
<input checked="" type="checkbox"/> Total Lead	6	6,950 -- 19,900	19,900	21,000 ( I )	400,000 ( I ) ( )

CLOSURE ASSESSMENT REPORT (Continued)

ATTACHMENT NO. 8 (CONTINUED) PAGE 2 OF 2

COMPARISON TABLE FOR SOIL VERIFICATION

FACILITY NAME Shell Service Station, 13580 Grand River

FACILITY NUMBER 221-2491-7703

Contaminant	Number of Samples Taken	Range of Detected Concentrations [Min - Max] (ug/kg)	Maximum Detected (ug/kg)	Applicable RBSL or SSTL Criterion [Specify Tier Level in ()]		
				Residential	Commercial III	Commercial IV
<b>PCBs</b>						
<input checked="" type="checkbox"/> Aroclor 1016	6	<230 -- <240	240	330 ( I )	( )	( )
<input checked="" type="checkbox"/> Aroclor 1221	6	<230 -- <240	240	330 ( I )	( )	( )
<input checked="" type="checkbox"/> Aroclor 1232	6	<230 -- <240	240	330 ( I )	( )	( )
<input checked="" type="checkbox"/> Aroclor 1242	6	<230 -- <240	240	330 ( I )	( )	( )
<input checked="" type="checkbox"/> Aroclor 1248	6	<230 -- <240	240	330 ( I )	( )	( )
<input checked="" type="checkbox"/> Aroclor 1254	6	<230 -- <240	240	330 ( I )	( )	( )
<input checked="" type="checkbox"/> Aroclor 1260	6	<230 -- <240	240	330 ( I )	( )	( )
<b>HALOGENATED HYDROCARBONS</b>						
<input checked="" type="checkbox"/> Carbon Tetrachloride	6	<1 -- <1	<1	100 ( I )	( )	( )
<input checked="" type="checkbox"/> 1,1-Dichloroethane	6	<2 -- <2	<2	18,000 ( I )	( )	( )
<input checked="" type="checkbox"/> 1,2-Dichloroethane	6	<1 -- <1	1	100 ( I )	( )	( )
<input checked="" type="checkbox"/> 1,1-Dichloroethylene	5	<2 -- <2	<2	140 ( I )	( )	( )
<input type="checkbox"/> cis-1,2-Dichloroethylene	0	--		( I )	( )	( )
<input checked="" type="checkbox"/> trans-1,2-Dichloroethylene	5	<2 -- <2	<2	2000 ( I )	( )	( )
<input checked="" type="checkbox"/> Tetrachloroethylene	5	<2 -- <2	<2	100 ( I )	( )	( )
<input checked="" type="checkbox"/> 1,1,2-Trichloroethane	6	<2 -- <2	<2	100 ( I )	( )	( )
<b>OTHER*</b>						
		--		( )	( )	( )
		--		( )	( )	( )
		--		( )	( )	( )
		--		( )	( )	( )
		--		( )	( )	( )
		--		( )	( )	( )
		--		( )	( )	( )

\*List additional contaminants as appropriate

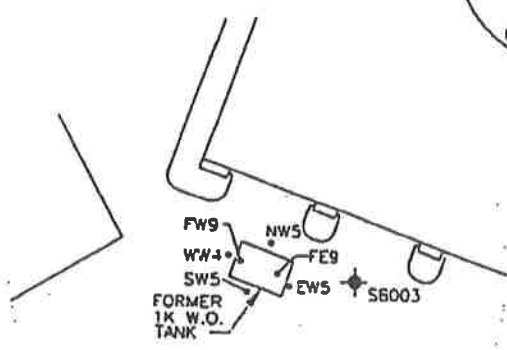
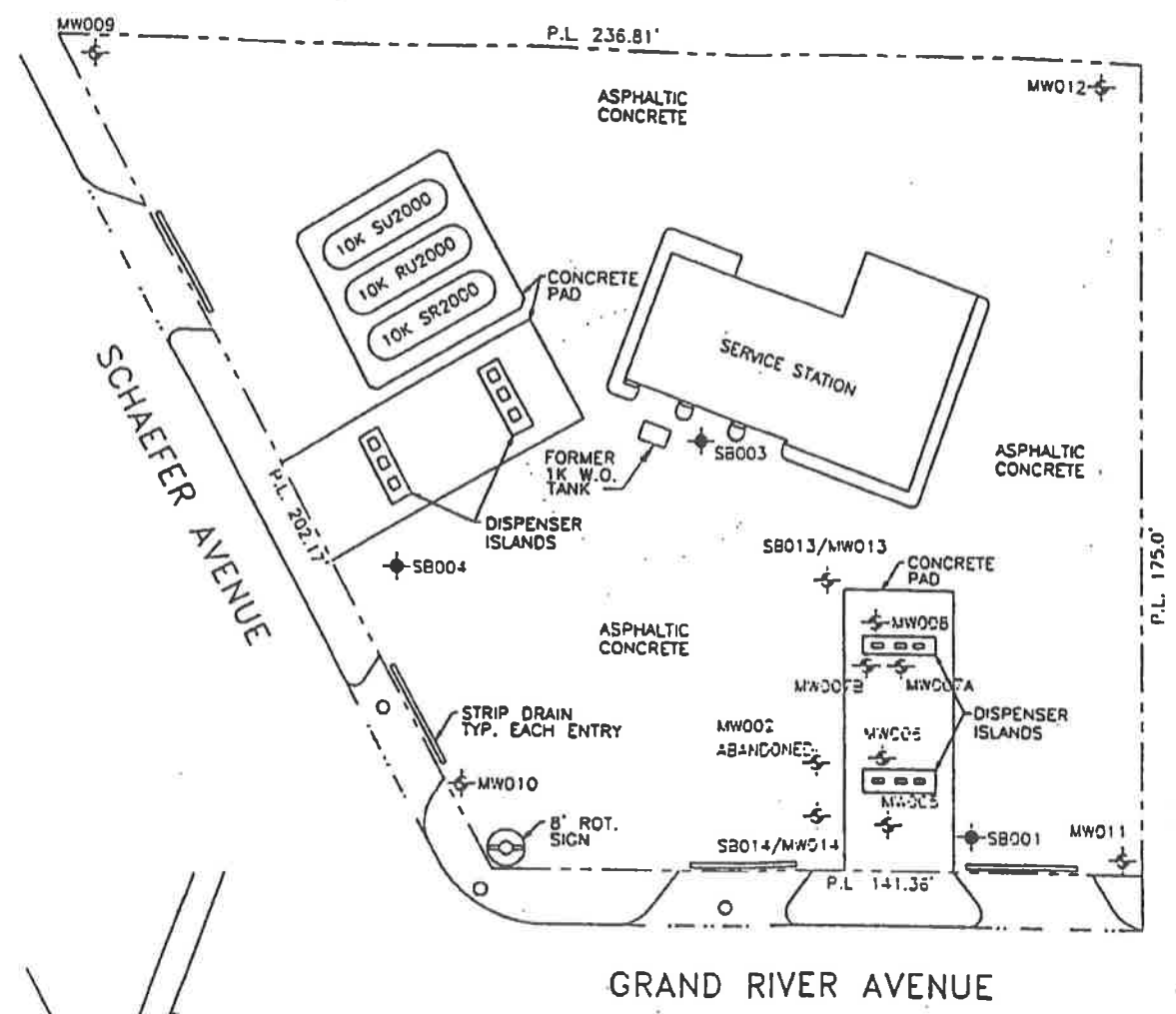
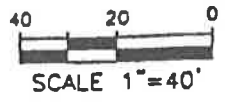

**EXPLANATION**

- ⊕ MONITORING WELL
- SOIL BORING
- SAMPLE POINT



Project: <b>FORMER SHELL SERVICE STATION</b>		<b>FORMER SITE MAP</b>	
13580 GRAND RIVER AVENUE DETROIT, MICHIGAN			
File No.: 810-099	ACAD File No.: 810099	Date: 10/21/97	REV.:
Drawn By: MRP	Design By: ;	Checked By:	Approved By: FIG. NO.:



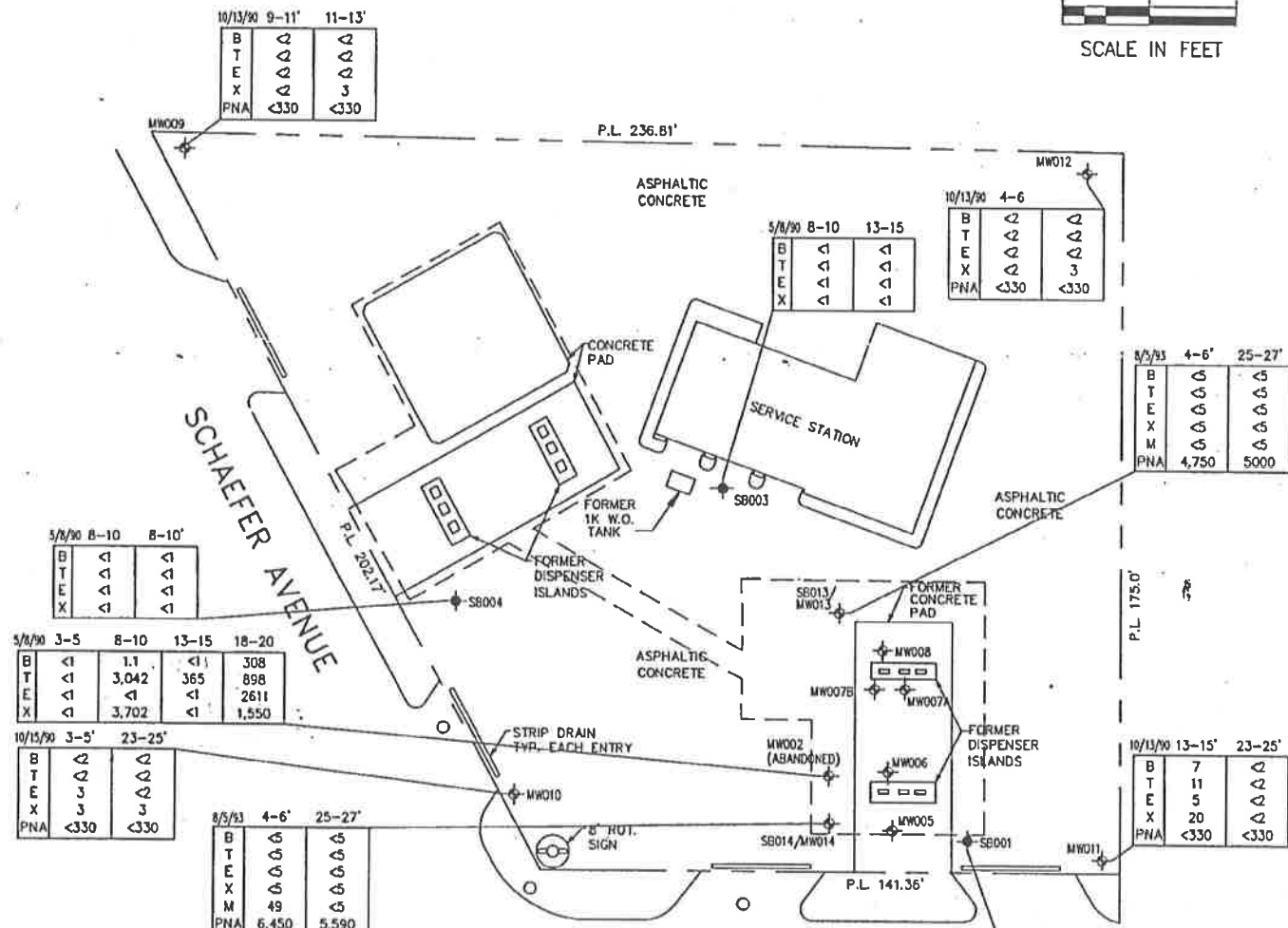
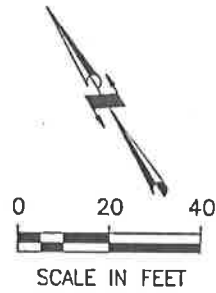

LEGEND

- ⊕ MONITORING WELL
- ⊙ SOIL BORING
- SAMPLE POINT
- B BENZENE
- T TOLUENE
- E ETHYLBENZENE
- X XYLENES
- M METHYL TERTIARY-BUTYL ETHER
- PNA POLYNUCLEAR AROMATICS
- Pb LEAD

NOTE: ALL RESULTS IN ug/kg, EXCEPT SB001 THROUGH SB004 WHICH WERE ANALYZED USING AN ONSITE GAS CHROMATOGRAPH UTILIZING A GAS HEADSPACE METHOD.



Project: FORMER SHELL SERVICE STATION  
 13580 GRAND RIVER AVENUE  
 DETROIT, MICHIGAN

SOIL ANALYTICAL MAP

File No.: 810-099	ACAD File No.: 810099	Date: 10/21/97	REV.:
Drawn By: MRP	Design By:	Checked By:	Approved By:
			FIG. NO.: 3

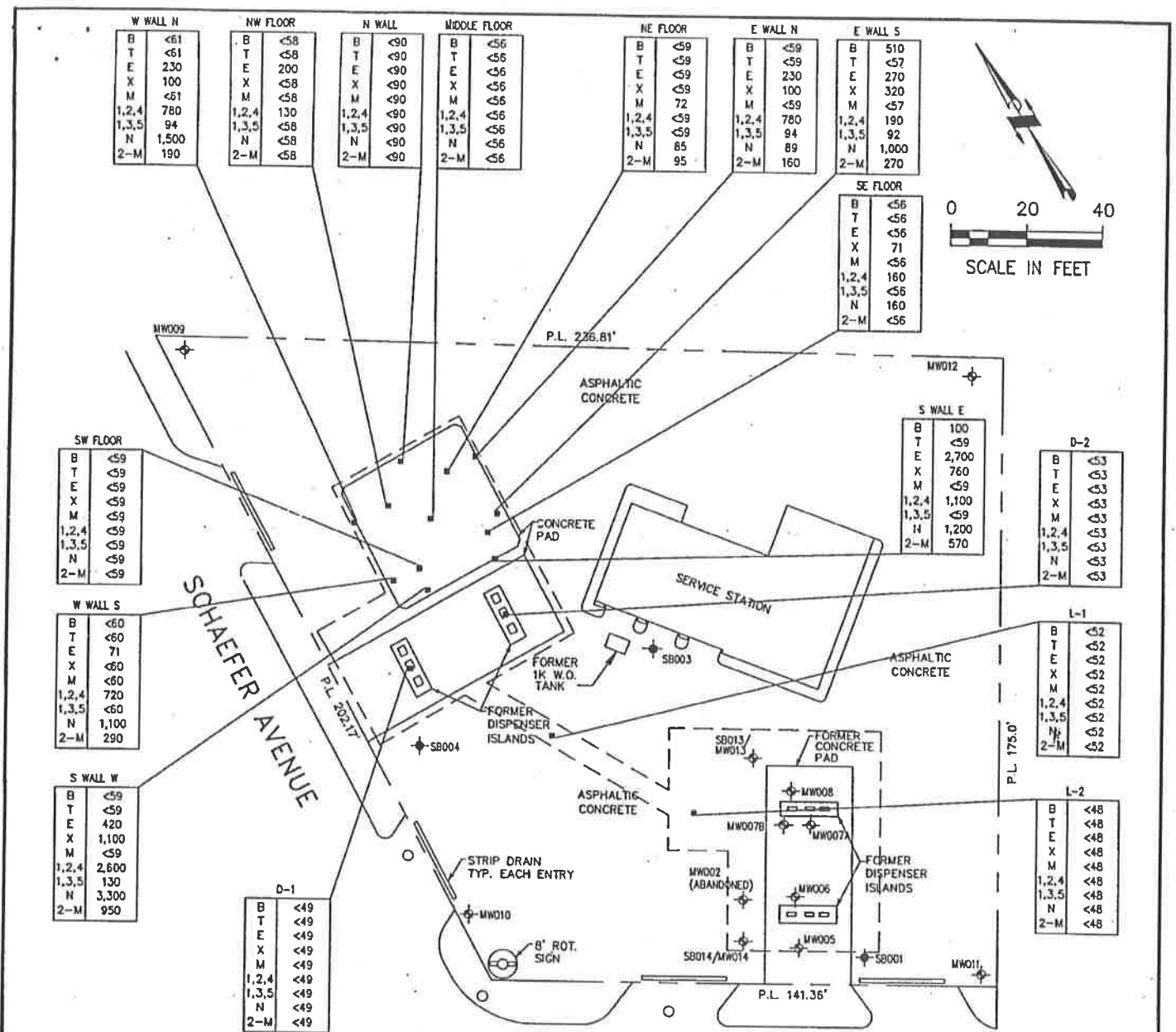

**LEGEND**

- ⊕ MONITORING WELL
- SOIL BORING
- SAMPLE POINT
- B BENZENE
- T TOLUENE
- E ETHYLBENZENE
- X XYLENES
- M METHYL TERTIARY-BUTYL ETHER
- 1,2,4 1,2,4 TRIMETHYLBENZENE
- 1,3,5 1,3,5 TRIMETHYLBENZENE
- N NAPHTHALENE
- 2-M 2-METHYLNAPHTHALENE

RESULTS IN ug/kg (ppb)  
 SAMPLES COLLECTED ON 11/3/98.  
 --- APPROXIMATE EXCAVATION BOUNDARY  
 NOTE: MONITORING WELLS REMOVED DURING EXCAVATION.



Project: FORMER SHELL SERVICE STATION		UST SYSTEM EXCAVATION SAMPLE LOCATIONS AND SOIL ANALYTICAL RESULTS	
13580 GRAND RIVER AVENUE DETROIT, MICHIGAN			
File No.: 810-099	ACAD File No.: 810099	Date: 10/21/97	REV.:
Drawn By: MRP	Design By:	Checked By:	Approved By:
		FIG. NO.:	

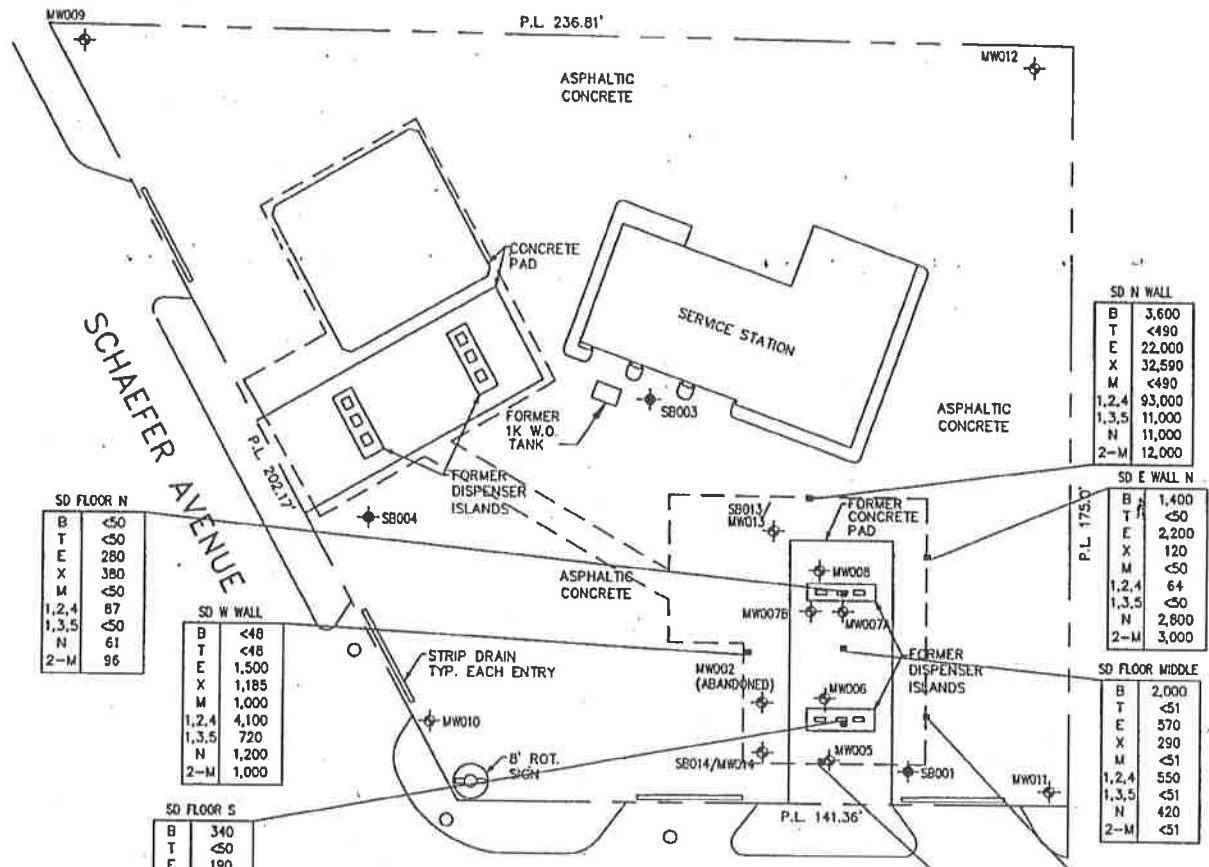
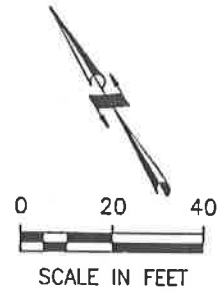

SD FLOOR N	
B	<50
T	<50
E	280
X	380
M	<50
1,2,4	87
1,3,5	<50
N	61
2-M	96

SD W WALL	
B	<48
T	<48
E	1,500
X	1,185
M	1,000
1,2,4	4,100
1,3,5	720
N	1,200
2-M	1,000

SD FLOOR S	
B	340
T	<50
E	190
X	180
M	<50
1,2,4	240
1,3,5	70
N	140
2-M	150

SD N WALL	
B	3,600
T	<490
E	22,000
X	32,590
M	<490
1,2,4	93,000
1,3,5	11,000
N	11,000
2-M	12,000

SD E WALL N	
B	1,400
T	<50
E	2,200
X	120
M	<50
1,2,4	64
1,3,5	<50
N	2,800
2-M	3,000

SD FLOOR MIDDLE	
B	2,000
T	<51
E	570
X	290
M	<51
1,2,4	550
1,3,5	<51
N	420
2-M	<51

SD S WALL	
B	3,700
T	10,000
E	20,000
X	96,000
M	<480
1,2,4	61,000
1,3,5	15,000
N	6,400
2-M	4,700

SD E WALL S	
B	2,500
T	320
E	2,550
X	59
M	2,500
1,2,4	690
1,3,5	1,800
N	1,400
2-M	

- LEGEND**
- ⊕ MONITORING WELL
  - SOIL BORING
  - SAMPLE POINT
  - B BENZENE
  - T TOLUENE
  - E ETHYLBENZENE
  - X XYLENES
  - M METHYL TERTIARY-BUTYL ETHER
  - 1,2,4 1,2,4 TRIMETHYLBENZENE
  - 1,3,5 1,3,5 TRIMETHYLBENZENE
  - N NAPHTHALENE
  - 2-M 2-METHYLNAPHTHALENE
- RESULTS IN ug/kg (ppb)  
 SAMPLES COLLECTED ON 11/4/98.  
 — APPROXIMATE EXCAVATION BOUNDARY  
 NOTE: MONITORING WELLS REMOVED DURING EXCAVATION.



Project: <b>FORMER SHELL SERVICE STATION</b>		<b>SOUTH DISPENSER EXCAVATION SAMPLE LOCATIONS AND SOIL ANALYTICAL RESULTS</b>	
13580 GRAND RIVER AVENUE DETROIT, MICHIGAN			
File No.: 810-099	ACAD File No.: 810099	Date: 10/21/97	REV:
Drawn By: MRP	Design By:	Checked By:	Approved By:
		FIG. NO.:	

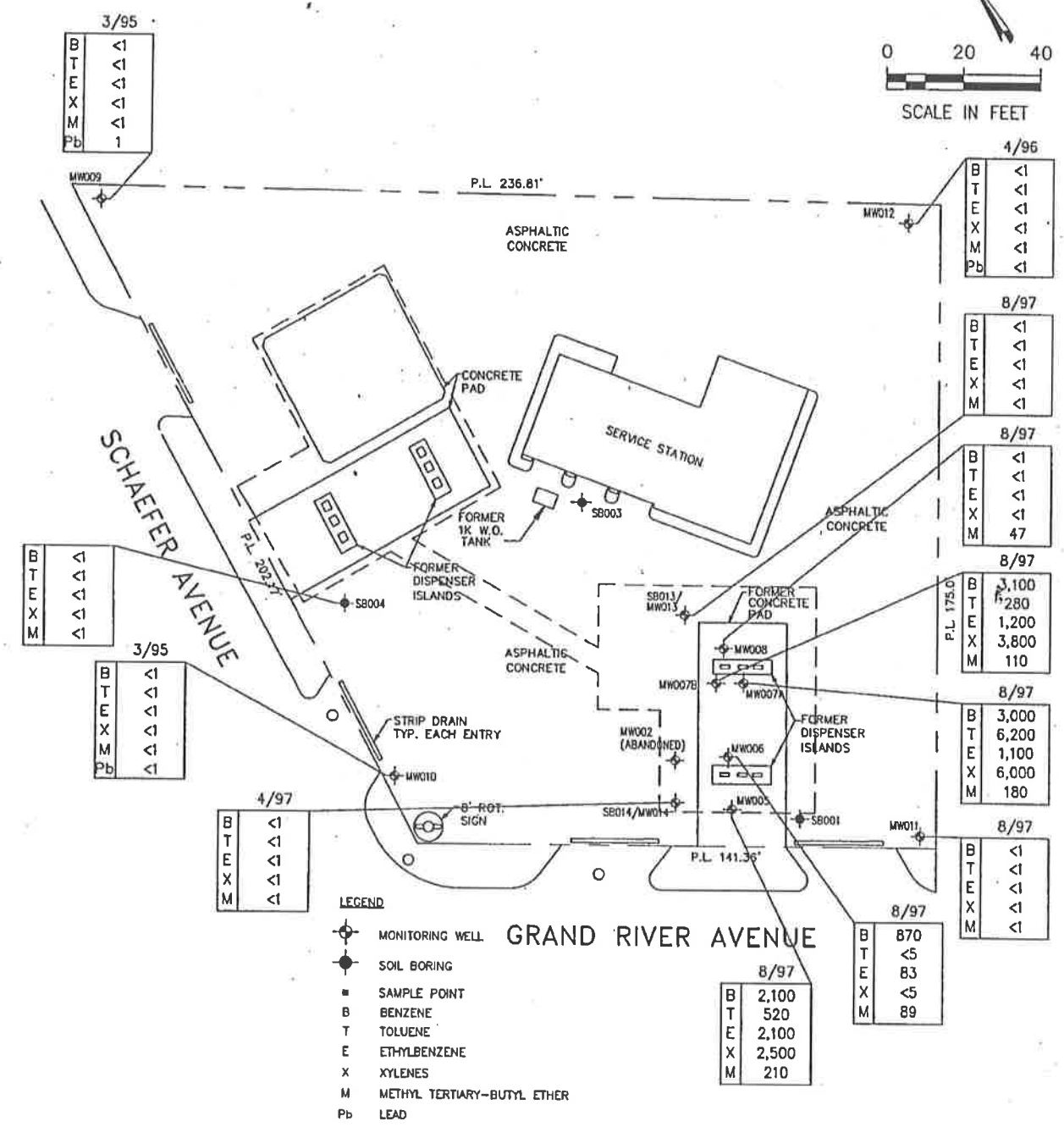
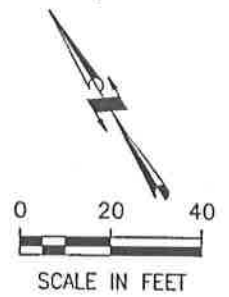

3/95

B	<1
T	<1
E	<1
X	<1
M	<1
Pb	1

4/96

B	<1
T	<1
E	<1
X	<1
M	<1
Pb	<1

8/97

B	<1
T	<1
E	<1
X	<1
M	<1

8/97

B	<1
T	<1
E	<1
X	<1
M	47

8/97

B	3,100
T	280
E	1,200
X	3,800
M	110

8/97

B	3,000
T	6,200
E	1,100
X	6,000
M	180

8/97

B	<1
T	<1
E	<1
X	<1
M	<1

8/97

B	870
T	<5
E	83
X	<5
M	89

8/97

B	2,100
T	520
E	2,100
X	2,500
M	210

- LEGEND
- ⊕ MONITORING WELL
  - SOIL BORING
  - SAMPLE POINT
  - B BENZENE
  - T TOLUENE
  - E ETHYLBENZENE
  - X XYLENES
  - M METHYL TERTIARY-BUTYL ETHER
  - Pb LEAD



Project: **FORMER SHELL SERVICE STATION**  
 13580 GRAND RIVER AVENUE  
 DETROIT, MICHIGAN

**GROUNDWATER ANALYTICAL MAP**

File No.: 810-099	ACAD File No.: 810099	Date: 10/21/97	REV.:
Drawn By: MRP	Design By:	Checked By:	Approved By:
			FIG. NO.: 4

Groundwater Analytical Results  
 Shell Service Station  
 13580 Grand River  
 Detroit, Michigan  
 0400810099

Water Sample	Sample Identification	Date	Benzene (ug/L)	Toluene (ug/L)	Ethylbenzene (ug/L)	Xylene (ug/L)	MTBE (ug/L)
Criteria			9,200 <sup>A</sup>	5.3E+5 <sup>B</sup>	1.7E+5 <sup>B</sup>	1.9E+5 <sup>B</sup>	5.8E+5 <sup>C</sup>
SB001		4/10/97	230	3	2	3	14
SB004		4/10/97	4	20	100	81	52
SB005		4/10/97	58	1	1	8	90
MW001		4/10/97	520	4	6	1	10
MW005		8/20/97	2100	520	2100	2500	310
MW006		8/20/97	870	ND	83	ND	89
MW007A		8/20/97	3000	6200	1100	6000	180
MW007B		8/20/97	3100	280	1200	3800	110
MW008		8/20/97	ND	ND	ND	ND	47
MW011		8/20/97	ND	ND	ND	ND	ND
MW013		8/20/97	ND	ND	ND	ND	ND

- A: Comm. III GW Direct Contact
- B: Comm. III GW/IA/ GW Direct Contact/ Solubility
- C: Comm. III GW Direct Contact
- D: Comm. III GW Direct Contact/Solubility

ND: Not detected

Groundwater Analytical Results  
 Shell Service Station  
 13580 Grand River  
 Detroit, Michigan  
 0400810099

Water Sample	Sample Identification	Date	Lead (ug/L)	Cadmium (ug/L)	Chromium (ug/L)	Arsenic 1016 (ug/L)	Arsenic 1221 (ug/L)	Arsenic 1222 (ug/L)	Arsenic 1242 (ug/L)	Arsenic 1248 (ug/L)	Arsenic 1284 (ug/L)	Arsenic 1360 (ug/L)
Criteria			NC	1.1E-5 <sup>a</sup>	1.0E-6 <sup>b</sup>	2.4 <sup>a</sup>	2.4 <sup>a</sup>	2.4 <sup>a</sup>	2.4 <sup>a</sup>	2.4 <sup>a</sup>	2.4 <sup>a</sup>	2.4 <sup>a</sup>
SB001		4/10/97	<0.001	<0.0002	<0.001	<0.2	<0.2	<0.2	<0.2	<0.2	<0.2	<0.2
SB004		4/10/97	0.003	<0.0002	<0.001	<0.2	<0.2	<0.2	<0.2	<0.2	<0.2	<0.2
SB005		4/10/97	<0.001	NA	NA	NA	NA	NA	NA	NA	NA	NA
MM001		8/26/97	NA	NA	*0.021	NA	NA	NA	NA	NA	NA	NA

A: Commercial III Groundwater Direct Contact  
 NC: No Criteria  
 NA: Not analyzed



Groundwater Analytical Results  
 Shell Service Station  
 1350 Grand River  
 Detroit, Michigan  
 04081003

Parameter	Unit	4/10/97	4/10/97	4/10/97	4/10/97	4/10/97	4/10/97	4/10/97	4/10/97	4/10/97
Chloride	mg/L	<0.9	<2.5	<2	<0.3	<3.2	<3.4	<1.5	<1.5	<1.5
Cyanide	mg/L	<0.9	<2.5	<2	<0.3	<3.2	<3.4	<1.5	<1.5	<1.5

A: Comma III GW Direct Contact Criteria  
 B: Comma III GW Indirect Contact Criteria  
 C: Comma III GW Dated Contact Criteria  
 D: Comma III GW Dated Contact Criteria  
 NC: No criteria

Groundwater Analytical Results  
 Shell Service Station  
 Granddams River  
 Deane, Michigan  
 0400810098

Sample	Sample Identification	Date	Dichloro- difluoro- methane (ug/l)	Chloro- methane (ug/l)	Vinyl chloride (ug/l)	Bromo- methane (ug/l)	Chloro- ethane (ug/l)	Trichloro- ethane (ug/l)	1,1- dichloro- ethylene (ug/l)	Methylene chloride (ug/l)	Trans-1,2- Dichloro- ethylene (ug/l)	Cis-1,2- Dichloro- ethylene (ug/l)	1,1,1- trichloro- ethane (ug/l)	1,1,1- trichloro- ethylene (ug/l)	1,2- Dichloro- ethane (ug/l)	Bromo- chloro- methane (ug/l)	1,1,1,2- tetrachloro- ethane (ug/l)	1,1,1,2- tetrachloro- ethane (ug/l)	1,1,1,2- tetrachloro- ethane (ug/l)
SHS01		4/10/97	<1	<0.5	<1.8	<1	<1.2	<1	<1.3	<0.8	<1	<1.2	<0.3	<0.5	<0.4	<1	<1	<0.2	<0.2
SHS04		4/10/97	<1	<0.8	<1.8	<1	<1.2	<1	<1.3	<0.8	<1	<1.2	<0.3	<0.5	<0.4	<1	<1	<0.2	<0.2

A: Comm. II GW Direct Contact Criteria  
 B: Comm. II GW Volatilization to Indoor Air Criteria  
 C: Comm. II GW Volatilization to Indoor Air Criteria  
 D: Comm. II GW Direct Contact/Volatilization to Indoor Air/Soil  
 NC: No criteria

Groundwater Analytical Results  
 15500 Grand River  
 Detroit, Michigan  
 04/08/10059

Sample ID	Date	Ammonia Nitrogen (mg/L)	Ammonia Nitrogen (mg/L)	Ammonia Nitrogen (mg/L)	Ammonia Nitrogen (mg/L)	Ammonia Nitrogen (mg/L)	Ammonia Nitrogen (mg/L)	Ammonia Nitrogen (mg/L)	Ammonia Nitrogen (mg/L)	Ammonia Nitrogen (mg/L)	Ammonia Nitrogen (mg/L)	Ammonia Nitrogen (mg/L)	Ammonia Nitrogen (mg/L)	Ammonia Nitrogen (mg/L)	Ammonia Nitrogen (mg/L)	Ammonia Nitrogen (mg/L)	Ammonia Nitrogen (mg/L)	Ammonia Nitrogen (mg/L)
Sample ID	Date	Ammonia Nitrogen (mg/L)	Ammonia Nitrogen (mg/L)	Ammonia Nitrogen (mg/L)	Ammonia Nitrogen (mg/L)	Ammonia Nitrogen (mg/L)	Ammonia Nitrogen (mg/L)	Ammonia Nitrogen (mg/L)	Ammonia Nitrogen (mg/L)	Ammonia Nitrogen (mg/L)	Ammonia Nitrogen (mg/L)	Ammonia Nitrogen (mg/L)	Ammonia Nitrogen (mg/L)	Ammonia Nitrogen (mg/L)	Ammonia Nitrogen (mg/L)	Ammonia Nitrogen (mg/L)	Ammonia Nitrogen (mg/L)	Ammonia Nitrogen (mg/L)
BR001	8/10/97	<5	<5	<5	<5	<5	<5	<5	<5	<5	<5	<5	<5	<5	<5	<5	<5	<5
BR004	8/10/97	74	<25	<25	<25	<25	<25	<25	<25	<25	<25	<25	<25	<25	<25	<25	<25	<25
BR001	8/13/97	<5	<5	<5	<5	<5	<5	<5	<5	<5	<5	<5	<5	<5	<5	<5	<5	<5

A: Comm. III GWVADOC Solubility  
 B: Method of Detection Limit  
 C: Comm. III Groundwater DOC  
 D: Solubility

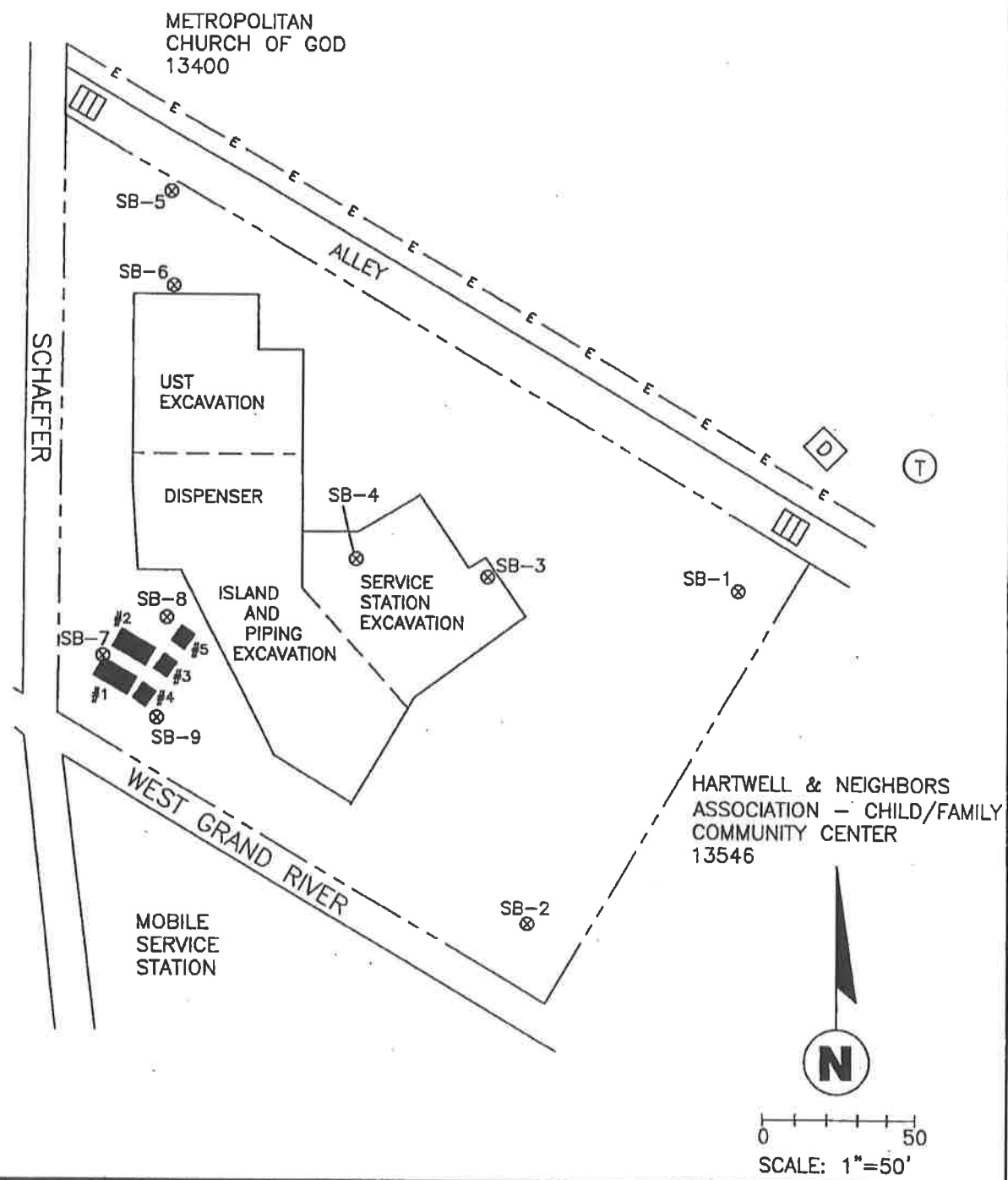

LEGEND	
---	SITE BOUNDARY
— E —	OVERHEAD ELECTRIC
☐	CATCH BASIN
⊙	POLE-MOUNTED TRANSFORMER
Ⓛ	DUMPSTER
SB-2 ⊙	SOIL BORING LOCATION AND NUMBER
■	IDENTIFIED USTs 1,2 = 2,000 GALLON 3,4,5 = 1,000 GALLON

FIGURE 2.0 SOIL BORING LOCATION MAP BASELINE ENVIRONMENTAL ASSESSMENT 13580 WEST GRAND RIVER AVENUE DETROIT, MICHIGAN	
PREPARED FOR THE VELMEIR COMPANIES WEST BLOOMFIELD, MICHIGAN	
DRAWN GT/5-1-01	CHECKED SC
REVISED	APPROVED RJA
JOB NO. 72121.04	
DRAWING NUMBER 72121-04SB	<b>TOLLEST, INC.</b>

**TABLE 1.0**  
**SOIL ANALYTICAL DATA - VOLATILES (ug/kg)**  
**Proposed CVS Store #8269**  
**Northeast Corner of Grand River Avenue**  
**and Schaefer Highway**  
**Detroit, Michigan**

Sample Location	CAS#	SB-1	SB-2	SB-3	SB-4	SB-5	SB-6	Part 201 Residential Drinking Water Protection Criteria	Part 201 Residential Direct Contact Criteria	Part 201 Residential Soil Volatilization to Indoor Air Inhalation Criteria
		8-9'	7-8'	5-6'	3-4'	3-4'	3-4'			
Date Sampled		3/12/01	3/12/01	3/12/01	3/12/01	3/12/01	3/12/01			
		Conc.	Conc.	Conc.	Conc.	Conc.	Conc.			
Benzene	71432	ND	ND	ND	ND	ND	ND	100	180,000	1,600
1,2 - Dibromoethane	106934	ND	ND	ND	ND	ND	ND	10	92	670
1,2 - Dichloroethane	107062	ND	ND	ND	ND	ND	ND	100	91,000	2,100
Ethylbenzene	100414	ND	ND	ND	ND	7,700	ND	1,500	140,000	140,000
2-Methylnaphthalene	91576	ND	ND	ND	ND	ND	ND	57,000	8,100,000	ID
Methyl-(tert)-butyl-ether	1634044	ND	ND	ND	ND	ND	ND	800	1,800,000	5,900,000
Naphthalene	91203	ND	ND	ND	ND	200	ND	35,000	16,000,000	250,000
Toluene	108883	ND	ND	ND	ND	ND	ND	16,000	250,000	250,000
1,3,5 - Trimethylbenzene	108678	ND	ND	ND	ND	500	ND	1,800	94,000	94,000
1,2,4 - Trimethylbenzene	95636	ND	ND	ND	ND	2,600	ND	2,100	110,000	110,000
Xylenes	1330207	ND	ND	ND	ND	1,200	ND	5,600	150,000	150,000
Isopropylbenzene	98828	ND	ND	ND	ND	830	ND	91,000	390,000	390,000
n-Butylbenzene	104518	ND	ND	ND	ND	450	ND	1,600	2,500,000	ID
sec-Butylbenzene	135988	ND	ND	ND	ND	140	ND	1,600	2,500,000	ID
n-Propylbenzene	103651	ND	ND	ND	ND	2,700	ND	1,600	2,500,000	ID

ND = Not Detected at the reporting limit

All results for analytes not listed on table were non-detect.

ID = Inadequate data to develop criteria.

NA = Sample not analyzed for this chemical.

**TABLE 1.0**  
**SOIL ANALYTICAL DATA - VOLATILES (ug/kg)**  
**Proposed CVS Store #8269**  
**Northeast Corner of Grand River Avenue**  
**and Schaefer Highway**  
**Detroit, Michigan**

Sample Location	CAS#	SB-7	SB-8	SB-9	Part 201 Residential Drinking Water Protection Criteria	Part 201 Residential Direct Contact Criteria	Part 201 Residential Soil Volatilization to Indoor Air Inhalation Criteria
		6-7'	4-5'	3.5'-4.5'			
Date Sampled		3/12/01	3/12/01	3/12/01			
		Conc.	Conc.	Conc.			
Benzene	71432	ND	ND	ND	100	180,000	1,600
1,2 - Dibromoethane	106934	ND	ND	ND	10	92	670
1,2 - Dichloroethane	107062	ND	ND	ND	100	91,000	2,100
Ethylbenzene	100414	ND	ND	ND	1,500	140,000	140,000
2-Methylnaphthalene	91576	ND	ND	ND	57,000	8,100,000	ID
Methyl-(tert)-butyl-ether	1634044	NA	NA	NA	800	1,800,000	5,900,000
Naphthalene	91203	ND	ND	ND	35,000	16,000,000	250,000
Toluene	108883	ND	ND	ND	16,000	250,000	250,000
1,3,5 - Trimethylbenzene	108678	ND	ND	ND	1,800	94,000	94,000
1,2,4 - Trimethylbenzene	95636	ND	ND	ND	2,100	110,000	110,000
Xylenes	1330207	ND	ND	ND	5,600	150,000	150,000
Isopropylbenzene	98828	NA	NA	NA	91,000	390,000	390,000
n-Butylbenzene	104518	NA	NA	NA	1,600	2,500,000	ID
sec-Butylbenzene	135988	NA	NA	NA	1,600	2,500,000	ID
n-Propylbenzene	103651	NA	NA	NA	1,600	2,500,000	ID

ND = Not Detected at the reporting limit

All results for analytes not listed on table were non-detect.

ID = Inadequate data to develop criteria.

NA = Sample not analyzed for this chemical.



TABLE 2.0  
 SOIL ANALYTICAL DATA - PNAs (ug/kg)  
 Proposed CVS Store #8269  
 Northeast Corner of Grand River Avenue  
 and Schaefer Highway  
 Detroit, Michigan

Sample Location	CAS#	SB-1		SB-2		SB-3		SB-4		SB-5		SB-6		Part 201 Residential Drinking Water Protection Criteria	Part 201 Residential Direct Contact Criteria	Part 201 Residential Soil Volatilization to Indoor Air Inhalation Criteria
		8-9'	3/12/01	7-8'	3/12/01	5-6'	3/12/01	3-4'	3/12/01	3-4'	3/12/01	3-4'	3/12/01			
Date Sampled		3/12/01	Conc.	3/12/01	Conc.	3/12/01	Conc.	3/12/01	Conc.	3/12/01	Conc.	3/12/01	Conc.			
Acenaphthene	83329	NA	NA	NA	NA	NA	NA	ND	ND	ND	ND	ND	ND	300,000	41,000,000	190,000,000
Acenaphthylene	208968	NA	NA	NA	NA	NA	NA	ND	ND	ND	ND	ND	ND	5,900	1,600,000	1,600,000
Anthracene	120127	NA	NA	NA	NA	NA	NA	ND	ND	ND	ND	ND	ND	41,000	230,000,000	1,000,000,000
Benzo(a)anthracene	56553	NA	NA	NA	NA	NA	NA	ND	ND	ND	ND	ND	ND	NLL	20,000	NLV
Benzo(a)pyrene	50328	NA	NA	NA	NA	NA	NA	ND	ND	ND	ND	ND	ND	NLL	2,000	NLV
Benzo(b)fluoranthene	205992	NA	NA	NA	NA	NA	NA	ND	ND	ND	ND	ND	ND	NLL	20,000	NLV
Benzo(g,h,i)perylene	191242	NA	NA	NA	NA	NA	NA	ND	ND	ND	ND	ND	ND	NLL	2,500,000	NLV
Benzo(k)fluoranthene	207089	NA	NA	NA	NA	NA	NA	ND	ND	ND	ND	ND	ND	NLL	200,000	NLV
Chrysene	218019	NA	NA	NA	NA	NA	NA	ND	ND	ND	ND	ND	ND	NLL	2,000,000	ID
Dibenz(a,h)anthracene	35703	NA	NA	NA	NA	NA	NA	ND	ND	ND	ND	ND	ND	NLL	2,000	NLV
Fluoranthene	206440	NA	NA	NA	NA	NA	NA	ND	ND	ND	ND	ND	ND	730,000	46,000,000	1,000,000,000
Fluorene	86737	NA	NA	NA	NA	NA	NA	ND	ND	180	ND	ND	ND	390,000	27,000,000	580,000,000
Indeno(1,2,3-c,d)pyrene	193395	NA	NA	NA	NA	NA	NA	ND	ND	ND	ND	ND	ND	NLL	20,000	NLV
2-Methylnaphthalene	91576	NA	NA	NA	NA	NA	NA	ND	ND	120	ND	ND	ND	57,000	8,100,000	ID
Naphthalene	91203	NA	NA	NA	NA	NA	NA	ND	ND	340	ND	ND	ND	35,000	16,000,000	250,000
Phenanthrene	85018	NA	NA	NA	NA	NA	NA	ND	ND	120	ND	ND	ND	56,000	1,600,000	1,800,000
Pyrene	129000	NA	NA	NA	NA	NA	NA	ND	ND	130	ND	ND	ND	480,000	29,000,000	1,000,000,000

NA = Sample not analyzed for this chemical  
 ID = Inadequate data to develop criteria.  
 ND = Not detected at the reporting limit  
 NLV = Chemical not likely to volatilize

**TABLE 2.0**  
**SOIL ANALYTICAL DATA - PNAs (ug/kg)**  
**Proposed CVS Store #8269**  
**Northeast Corner of Grand River Avenue**  
**and Schaefer Highway**  
**Detroit, Michigan**

Sample Location	CAS#	SB-7		SB-8		SB-9		Part 201 Residential Drinking Water Protection Criteria	Part 201 Residential Direct Contact Criteria	Part 201 Residential Soil Volatilization to Indoor Air Inhalation Criteria
		6-7'	3/12/01	4-5'	3/12/01	3.5'-4.5'	3/12/01			
Acenaphthene	83329	ND	ND	400	ND	ND	ND	300,000	41,000,000	190,000,000
Acenaphthylene	208968	ND	ND	ND	ND	ND	ND	5,900	1,600,000	1,600,000
Anthracene	120127	ND	ND	110	ND	ND	ND	41,000	230,000,000	1,000,000,000
Benzo(a)anthracene	56553	ND	ND	ND	ND	640	ND	NLL	20,000	NLV
Benzo(a)pyrene	50328	ND	ND	ND	ND	800	ND	NLL	2,000	NLV
Benzo(b)fluoranthene	205992	ND	ND	ND	ND	1,300	ND	NLL	20,000	NLV
Benzo(g,h,i)perylene	191242	ND	ND	ND	ND	730	ND	NLL	2,500,000	NLV
Benzo(k)fluoranthene	207089	ND	ND	ND	ND	670	ND	NLL	200,000	NLV
Chrysene	218019	ND	ND	ND	ND	910	ND	NLL	2,000,000	ID
Dibenz(a,h)anthracene	35703	ND	ND	ND	ND	90	ND	NLL	2,000	NLV
Fluoranthene	206440	ND	ND	ND	ND	1,700	ND	730,000	46,000,000	1,000,000,000
Fluorene	86737	ND	ND	450	ND	ND	ND	390,000	27,000,000	580,000,000
Indeno(1,2,3-c,d)pyrene	193395	ND	ND	ND	ND	780	ND	NLL	20,000	NLV
2-Methylnaphthalene	91576	ND	ND	1,800	ND	ND	ND	57,000	8,100,000	ID
Naphthalene	91203	ND	ND	100	ND	ND	ND	35,000	16,000,000	250,000
Phenanthrene	85018	ND	ND	1,300	ND	620	ND	56,000	1,600,000	1,800,000
Pyrene	129000	ND	ND	ND	ND	1,300	ND	480,000	29,000,000	1,000,000,000

NA = Sample not analyzed for this chemical  
ID = Inadequate data to develop criteria.  
ND = Not detected at the reporting limit  
NLV = Chemical not likely to volatilize

**TABLE 3.0**  
**SOIL ANALYTICAL DATA - METALS (ug/kg)**  
**Proposed CVS Store #8269**  
**Northeast Corner of Grand River Avenue**  
**and Schaefer Highway**  
**Detroit, Michigan**

Sample Location	CAS#	SB-1		SB-2		SB-3		SB-4		SB-5		SB-6		Part 201 Residential Drinking Water Protection Criteria	Part 201 Residential Direct Contact Criteria
		8-9'	3/12/01	7-8'	3/12/01	5-6'	3/12/01	3-4'	3/12/01	3-4'	3/12/01	3-4'	3/12/01		
Arsenic	7440382	4,800	8,700	8,700	2,800	11,000	NA	NA	NA	23,000	7,600				
Barium	7440393	27,000	58,000	64,000	64,000	65,000	NA	NA	NA	1,300,000	37,000,000				
Cadmium	7440439	72	170	40	190	190	NA	NA	NA	6,000	550,000				
Chromium	18540299	11,000	16,000	25,000	25,000	21,000	NA	NA	NA	30,000	2,500,000				
Copper	7440508	1,800	8,000	8,000	5,600	9,500	NA	NA	NA	5,800,000	20,000,000				
Lead	7439921	4,500	6,100	6,100	6,700	11,000	NA	NA	NA	700,000	400,000				
Selenium	7782492	ND	ND	ND	ND	ND	NA	NA	NA	4,000	2,600,000				
Silver	7440224	600	300	300	ND	ND	NA	NA	NA	4,500	2,500,000				
Zinc	7440666	29,000	39,000	54,000	54,000	45,000	NA	NA	NA	2,400,000	170,000,000				
Mercury	7439976	ND	ND	800	800	890	NA	NA	NA	1,700	160,000				

According to MDEQ operational memorandum #18, June 9, 2000, metals not likely to volatilize.

NA = Sample not analyzed for this chemical.

**TABLE 3.0**  
**SOIL ANALYTICAL DATA - METALS (ug/kg)**  
**Proposed CVS Store #8269**  
**Northeast Corner of Grand River Avenue**  
**and Schaefer Highway**  
**Detroit, Michigan**

Sample Location	CAS#	SB-7	SB-8	SB-9	Part 201 Residential Drinking Water Protection Criteria	Part 201 Residential Direct Contact Criteria
		6-7'	4-5'	3.5'-4.5'		
Date Sampled		3/12/01	3/12/01	3/12/01		
		Conc.	Conc.	Conc.		
Arsenic	7440382	NA	NA	NA	23,000	7,600
Barium	7440393	NA	NA	NA	1,300,000	37,000,000
Cadmium	7440439	NA	NA	NA	6,000	550,000
Chromium	18540299	NA	NA	NA	30,000	2,500,000
Copper	7440508	NA	NA	NA	5,800,000	20,000,000
Lead	7439921	9,000	8,700	450,000	700,000	400,000
Selenium	7782492	NA	NA	NA	4,000	2,600,000
Silver	7440224	NA	NA	NA	4,500	2,500,000
Zinc	7440666	NA	NA	NA	2,400,000	170,000,000
Mercury	7439976	NA	NA	NA	1,700	160,000

According to MDEQ operational memorandum #18, June 9, 2000, metals not likely to volatilize.  
NA = Sample not analyzed for this chemical.

**TABLE 4.0**  
**SOIL ANALYTICAL DATA - PCBs (ug/kg)**  
**Proposed CVS Store #8269**  
**Northeast Corner of Grand River Avenue**  
**and Schaefer Highway**  
**Detroit, Michigan**

Sample Location	CAS#	SB-7	SB-8	SB-9	Part 201 Soil Volatilization to Indoor Air Inhalation Criteria	Part 201 Residential Direct Contact Criteria
		6-7'	4-5'	3.5'-4.5'		
		3/12/01	3/12/01	3/12/01		
		Conc.	Conc.	Conc.		
ARO 1016	1336363	NA	NA	NA	3,000,000	4,000
ARO 1221	1336363	NA	NA	NA	3,000,000	4,000
ARO 1232	1336363	NA	NA	NA	3,000,000	4,000
ARO 1242	1336363	NA	NA	NA	3,000,000	4,000
ARO 1248	1336363	NA	NA	NA	3,000,000	4,000
ARO 1254	1336363	NA	NA	NA	3,000,000	4,000
ARO 1260	1336363	NA	NA	NA	3,000,000	4,000

NA = Sample not analyzed for this chemical

ND = Not detected at the reporting limit

Part 201 drinking water protection criteria are not shown because according to MDEQ operational memorandum #18, June 9, 2000, PCBs are not likely to leach into groundwater

**TABLE 4.0**  
**SOIL ANALYTICAL DATA - PCBs (ug/kg)**  
**Proposed CVS Store #8269**  
**Northeast Corner of Grand River Avenue**  
**and Schaefer Highway**  
**Detroit, Michigan**

Sample Location	CAS#	SB-1		SB-2		SB-3		SB-4		SB-5		SB-6		Part 201 Soil Volatilization to Indoor Air Inhalation Criteria	Part 201 Residential Direct Contact Criteria
		8-9'	3/12/01	7-8'	3/12/01	5-6'	3/12/01	3-4'	3/12/01	3-4'	3/12/01	3-4'	3/12/01		
Sample Depth (bgs)		8-9'	3/12/01	7-8'	3/12/01	5-6'	3/12/01	3-4'	3/12/01	3-4'	3/12/01	3-4'	3/12/01		
Date Sampled		Conc.	Conc.	Conc.	Conc.	Conc.	Conc.	Conc.	Conc.	Conc.	Conc.	Conc.	Conc.		
ARO 1016	1336363	NA	NA	NA	NA	ND	ND	ND	ND	ND	ND	ND	ND	3,000,000	4,000
ARO 1221	1336363	NA	NA	NA	NA	ND	ND	ND	ND	ND	ND	ND	ND	3,000,000	4,000
ARO 1232	1336363	NA	NA	NA	NA	ND	ND	ND	ND	ND	ND	ND	ND	3,000,000	4,000
ARO 1242	1336363	NA	NA	NA	NA	ND	ND	ND	ND	ND	ND	ND	ND	3,000,000	4,000
ARO 1248	1336363	NA	NA	NA	NA	ND	ND	ND	ND	ND	ND	ND	ND	3,000,000	4,000
ARO 1254	1336363	NA	NA	NA	NA	ND	ND	ND	ND	ND	ND	ND	ND	3,000,000	4,000
ARO 1260	1336363	NA	NA	NA	NA	ND	ND	ND	ND	ND	ND	ND	ND	3,000,000	4,000

NA = Sample not analyzed for this chemical

ND = Not detected at the reporting limit

Part 201 drinking water protection criteria are not shown because according to MDEQ operational memorandum #18, June 9, 2000, PCBs are not likely to leach into groundwater.



**TABLE 5.0  
GROUNDWATER ANALYTICAL DATA - VOLATILES (ug/L)**

**Proposed CVS Store #8269  
Northeast Corner of Grand River Avenue  
and Schaefer Highway  
Detroit, Michigan**

Sample Location	CAS#	SB-5		SB-9		Part 201 Residential Drinking Water Criteria	Part 201 Residential Groundwater Contact Criteria	Part 201 Residential Volatilization to Indoor Air Inhalation Criteria
		4-6'	8-10'	3/12/01 Conc.	3/12/01 Conc.			
Date Sampled		3/12/01	3/12/01	3/12/01	3/12/01	5	11,000	5,600
Benzene	71432	410	6.0	6.0	6.0	5	11,000	5,600
1,2 - Dibromoethane	106934	ND	ND	ND	ND	1	25	2,400
1,2 - Dichloroethane	107062	ND	ND	ND	ND	5	19,000	9,600
Ethylbenzene	100414	3,600	7.1	7.1	7.1	74	170,000	170,000
2-Methylnaphthalene	91576	ND	330	330	330	260	25,000	ID
Methyl-tert-butyl-ether	1634044	ND	NA	NA	NA	40	690,000	47,000,000
Naphthalene	91203	570	350	350	350	520	31,000	31,000
Toluene	108883	64	1.3	1.3	1.3	790	530,000	530,000
1,2,4-Trimethylbenzene	95636	3,300	32	32	32	63	56,000	56,000
1,3,5-Trimethylbenzene	108678	640	7.3	7.3	7.3	72	61,000	61,000
Xylenes	1330207	3,300	16	16	16	280	190,000	190,000
p-Isopropyltoluene	99876	33	NA	NA	NA	*	*	*
Isopropylbenzene	98828	480	NA	NA	NA	800	56,000	56,000
n-Butylbenzene	104518	190	NA	NA	NA	80	5,900	ID
sec-Butylbenzene	135988	ND	NA	NA	NA	80	4,400	ID
n-Propylbenzene	103651	620	NA	NA	NA	80	15,000	ID

ID = Inadequate data to develop criteria.

ND = Not detected at the reporting limit

All results for analytes not listed in table were non-detect.

\* - MDEQ does not have criteria for this chemical

**TABLE 6.0**  
**GROUNDWATER ANALYTICAL DATA - PNAs (ug/L)**  
**Proposed CVS Store #8269**  
**Northeast Corner of Grand River Avenue**  
**and Schaefer Highway**  
**Detroit, Michigan**

Sample Location	CAS#	SB-5		SB-9		Part 201 Residential Drinking Water Criteria	Part 201 Residential Groundwater Contact Criteria	Part 201 Residential Volatilization to Indoor Air Inhalation Criteria
		4-6'	8-10'	3-12/01	3-12/01			
		Conc.	Conc.	Conc.	Conc.			
Acenaphthene	83329	5.0	ND	ND	ND	1,300	4,200	4,200
Acenaphthylene	208968	ND	ND	ND	ND	52	3,900	3,900
Anthracene	120127	2	ND	ND	ND	43	43	43
Benzo(a)anthracene	56553	ND	ND	ND	ND	2.1	9.4	NLV
Benzo(a)pyrene	50328	ND	ND	ND	ND	5	5	NLV
Benzo(b)fluoranthene	205992	ND	ND	ND	ND	2	2	NLV
Benzo(g,h,i)perylene	191242	ND	ND	ND	ND	5	5	NLV
Benzo(k)fluoranthene	207089	ND	ND	ND	ND	5	5	NLV
Chrysene	218019	ND	ND	ND	ND	5	5	ID
Dibenz(a,h)anthracene	53703	ND	ND	ND	ND	5	5	NLV
Fluoranthene	206440	ND	ND	ND	ND	210	210	210
Fluorene	86737	6.0	ND	ND	ND	880	2,000	2,000
Indeno(1,2,3-c,d)pyrene	193395	ND	ND	ND	ND	5	5	NLV
2-Methylnaphthalene	91576	450	ND	ND	ND	260	25,000	ID
Naphthalene	91203	910	ND	ND	ND	520	31,000	31,000
Phenanthrene	85018	9.8	ND	ND	ND	52	1,000	1,000
Pyrene	129000	3.0	ND	ND	ND	140	140	140

NA = Sample not analyzed for this chemical.

ID = Inadequate data to develop criteria.

NLV = Chemical is not likely to volatilize under most conditions.

ND = Not detected at the reporting limit

**TABLE 7.0**  
**GROUNDWATER ANALYTICAL DATA - LEAD (ug/L)**  
**Proposed CVS Store #8269**  
**Northeast Corner of Grand River Avenue**  
**and Schaefer Highway**  
**Detroit, Michigan**

Sample Location	CAS#	SB-5	SB-9	Part 201 Residential Drinking Water Criteria	Part 201 Residential Groundwater Contact Criteria
Sample Depth (bgs)		4-6'	8-10'		
Date Sampled		3/12/01	3/12/01		
		Conc.	Conc.		
Lead	7439921	NA	7.3	4	ID
Cadmium	7440439	NA	NA	5	190,000
Chromium	18540299	NA	NA	100	460,000

NA = Sample not analyzed for this chemical.

ID = Inadequate data to develop criteria.

ND = Not detected at the reporting limit

According to MDEQ operational memorandum #18, June 9, 2000, metals not likely to volatilize under most conditions.

**TABLE 8.0**  
**GROUNDWATER ANALYTICAL DATA - PCBs (ug/L)**  
**Proposed CVS Store #8269**  
**Northeast Corner of Grand River Avenue**  
**and Schaefer Highway**  
**Detroit, Michigan**

Sample Location	CAS#	SB-5		SB-9		Part 201 Residential Drinking Water Criteria	Part 201 Residential Groundwater Contact Criteria	Part 201 Residential Volatilization to Indoor Air Criteria
		4-6'	8-10'	3/12/01	3/12/01			
Sample Depth (bgs)		Conc.	Conc.					
Date Sampled		3/12/01	3/12/01	3/12/01	3/12/01			
ARO 1016	1336363	ND	NA	NA	NA	0.5	3.3	45
ARO 1221	1336363	ND	NA	NA	NA	0.5	3.3	45
ARO 1232	1336363	ND	NA	NA	NA	0.5	3.3	45
ARO 1242	1336363	ND	NA	NA	NA	0.5	3.3	45
ARO 1248	1336363	ND	NA	NA	NA	0.5	3.3	45
ARO 1254	1336363	ND	NA	NA	NA	0.5	3.3	45
ARO 1260	1336363	ND	NA	NA	NA	0.5	3.3	45

NA = Sample not analyzed for this chemical

ND = Not detected at the reporting limit

**TABLE**  
**SUMMARY OF SOIL ANALYTICAL RESULTS**  
**VOLATILE ORGANIC COMPOUNDS, POLYNUCLEAR AROMATIC HYDROCARBONS, POLYCHLORINATED BIPHENYLS, CADMIUM, CHROMIUM, AND LEAD**  
**13580 GRAND RIVER AVENUE, DETROIT, MICHIGAN**  
**PM PROJECT #01-11327-0-0002**

VOLATILE ORGANIC COMPOUNDS (VOCs), POLYNUCLEAR AROMATIC HYDROCARBONS (PNA), POLYCHLORINATED BIPHENYLS (PCBs), CADMIUM, CHROMIUM, AND LEAD  (µg/kg)			n-Butylbenzene	sec-Butylbenzene	Ethylbenzene	2-Methylnaphthalene	Naphthalene	n-Propylbenzene	Other VOCs	Benzo(a)anthracene	Chrysene	Fluoranthene	2-Methylnaphthalene	Naphthalene	Pyrene	Other PNA	Polychlorinated Biphenyls	Cadmium	Chromium	Lead
Chemical Abstract Service Number (CAS#)			104518	135988	100414	91576	91203	103651	Various	56553	218019	206440	91576	91203	129000	Various	1336363	7440439	16065831	7439921
Sample ID	Sample Date	Sample Depth (feet bgs)	VOCs							PNA							PCBs	METALS		
SB-1	9/9/2019	4.0-5.0	<60	<60	<60	<100	<300	<60	ND	300	400	400	<300	<300	600	ND	<330	480	<b>20,800</b>	42,400
SB/SG-2	9/9/2019	5.0-6.0	<b>2,400</b>	800	<b>3,700</b>	<b>12,000</b>	<b>7,000</b>	9,300	ND	<300	<300	<300	<b>6,700</b>	<b>3,900</b>	<300	ND	NA	NA	NA	9,390
<b>Cleanup Criteria Requirements for Response Activity (R 299.1 - R 299.60)</b> <b>Generic Soil Cleanup Criteria Tables 2 and 3: Residential and Non-Residential Part 201 Generic Cleanup Criteria and Screening Levels /</b> <b>Part 213 Risk-Based Screening Levels (December 30, 2013)</b>																				
<b>Residential (µg/kg)</b>																				
<b>Statewide Default Background Levels</b>	NA	NA	NA	NA	NA	NA	NA	NA	NA	NA	NA	NA	NA	NA	NA	NA	NA	1,200	18,000	21,000
<b>Drinking Water Protection (Res DWP)</b>	1,800	1,800	1,500	57,000	35,000	1,800	Various	NLL	NLL	7.30E+05	57,000	35,000	4.80E+05	Various	NLL	NLL	6,000	30,000	7.00E+05	
<b>Groundwater Surface Water Interface Protection (GSIP)</b>	ID	ID	360	4,200	730	ID	Various	NLL	NLL	5.500	4,200	730	ID	Various	NLL	NLL	3,000 (G,X)	3,300	2.5E+06 (G,X)	
<b>Soil Volatilization to Indoor Air Inhalation (Res SVII)</b>	ID	ID	87,000	2.70E+06	2.50E+05	ID	Various	NLV	ID	1.0E+9 (D)	2.70E+06	2.50E+05	1.0E+9 (D)	Various	1.2E+03	NLV	NLV	NLV		
<b>Ambient Air Infinite Source Volatile Soil Inhalation (Res VSI)</b>	ID	ID	7.20E+05	1.50E+06	3.00E+05	ID	Various	NLV	ID	7.4E+08	1.50E+06	3.00E+05	6.5E+08	Various	2.40E+05	NLV	NLV	NLV		
<b>Ambient Air Finite VSI for 5 Meter Source Thickness</b>	ID	ID	1.00E+06	1.50E+06	3.00E+05	ID	Various	NLV	ID	7.4E+08	1.50E+06	3.00E+05	6.5E+08	Various	7.9E+06	NLV	NLV	NLV		
<b>Ambient Air Finite VSI for 2 Meter Source Thickness</b>	ID	ID	2.20E+06	1.50E+06	3.00E+05	ID	Various	NLV	ID	7.4E+08	1.50E+06	3.00E+05	6.5E+08	Various	7.9E+06	NLV	NLV	NLV		
<b>Ambient Air Particulate Soil Inhalation (Res PSI)</b>	2.00E+09	4.00E+08	1.00E+10	6.70E+08	2.00E+08	1.30E+09	Various	ID	ID	9.3E+09	6.70E+08	2.0E+08	6.7E+09	Various	5.2E+06	1.70E+06	2.80E+05	NA		
<b>Direct Contact (Res DC)</b>	2.50E+06	2.50E+06	2.2E+07 (C)	8.10E+06	1.80E+07	2.50E+06	Various	20,000	2.0E+06	4.8E+07	8.10E+06	1.8E+07	2.9E+07	Various	(T)	5.50E+05	2.50E+06	4.00E+05		
<b>Nonresidential (µg/kg)</b>																				
<b>Drinking Water Protection (Nonres DWP)</b>	4,800	4,800	1,500	1.70E+05	1.00E+05	4,800	Various	NLL	NLL	7.30E+05	1.70E+05	1.00E+05	4.80E+05	Various	NLL	NLL	6,000	30,000	7.00E+05	
<b>Soil Volatilization to Indoor Air Inhalation (Nonres SVII)</b>	ID	ID	4.6E+05 (C)	4.90E+06	4.70E+05	ID	Various	NLV	ID	1.0E+9 (D)	4.90E+06	4.70E+05	1.0E+9 (D)	Various	1.6E+07	NLV	NLV	NLV		
<b>Ambient Air Infinite Source Volatile Soil Inhalation (Nonres VSI)</b>	ID	ID	2.40E+06	1.80E+06	3.50E+05	ID	Various	NLV	ID	8.9E+08	1.80E+06	3.50E+05	7.8E+08	Various	8.10E+05	NLV	NLV	NLV		
<b>Ambient Air Finite VSI for 5 Meter Source Thickness</b>	ID	ID	3.10E+06	1.80E+06	3.50E+05	ID	Various	NLV	ID	8.9E+08	1.80E+06	3.50E+05	7.8E+08	Various	2.8E+07	NLV	NLV	NLV		
<b>Ambient Air Finite VSI for 2 Meter Source Thickness</b>	ID	ID	6.50E+06	1.80E+06	3.50E+05	ID	Various	NLV	ID	8.9E+08	1.80E+06	3.50E+05	7.8E+08	Various	2.8E+07	NLV	NLV	NLV		
<b>Ambient Air Particulate Soil Inhalation (Nonres PSI)</b>	ID	ID	1.30E+10	2.90E+08	8.80E+07	5.90E+08	Various	ID	ID	4.1E+09	2.90E+08	8.8E+07	2.9E+09	Various	8.5E+06	2.2E+06	2.40E+05	NA		
<b>Direct Contact (Nonres DC)</b>	8.00E+06	8.00E+06	7.1E+07 (C)	2.60E+07	5.20E+07	8.00E+06	Various	80,000	8.0E+06	1.3E+08	2.60E+07	5.2E+07	8.4E+07	Various	(T)	2.1E+06	9.20E+06	9.60E+05 (DD)		
<b>Screening Levels (µg/kg)</b>																				
<b>Soil Saturation Concentration Screening Levels (Csat)</b>	1.00E+07	1.00E+07	1.40E+05	NA	NA	1.00E+07	Various	NL	NL	NL	NL	NL	NL	Various	NL	NL	NL	NL		

  Applicable Criteria Exceeded  
**BOLD** Value Exceeds Applicable Criteria  
**bgs** Below Ground Surface (feet)  
**µg/kg** Micrograms per Kilogram  
**ND** Non-detected at levels above laboratory method detection limit (MDL)  
**NA** Not Analyzed/Not Applicable  
**NL** Not Listed  
**NLL** Not Likely to Leach  
**NLV** Not Likely to Volatilize  
**ID** Insufficient Data  
**(G)** Metal GSIP Criteria for Surface Water Protected for Drinking Water Use based on 307 mg/L CaCO3 Hardness Station ID 820328, River Rouge at Fankell Avenue, Detroit, MI  
**(T)** Refer to the Toxic Substances Control Act (TSCA), 40 CFR 761, Subparts D and G, as amended, to determine the applicability of TSCA cleanup standards. Alternatives to compliance with the standards listed below are possible under Subpart D.  
 New Releases may be subject to the standards identified in Subpart G. Use Part 201 soil direct contact criteria in the table below where TSCA standards are not applicable.

LAND USE CATEGORY	TSCA, Subpart D	Part 201
Residential	1,000 µg/Kg, or	4,000 µg/Kg
Nonresidential	10,000 µg/Kg if capped	16,000 µg/Kg

**TABLE 2  
SUMMARY OF SOIL GAS ANALYTICAL RESULTS  
VOLATILE ORGANIC COMPOUNDS  
13580 GRAND RIVER AVENUE, DETROIT, MICHIGAN  
PM PROJECT #01-11327-0-0002**

VOLATILE ORGANIC COMPOUNDS (VOCs) ( $\mu\text{g}/\text{m}^3$ )			Benzene	Ethylbenzene	1,2,4-Trimethylbenzene	Toluene	Xylenes (total)	Other VOCs
Chemical Abstract Service Number (CAS#)			71432	100414	95636	108883	1330207	Various
Sample ID	Sample Date	Sample Depth (feet bgs)						
SB/SG-2	9/9/2019	4.5	200	990	9.8	38	56	ND
<b>MDEQ Media Specific Volatilization to Indoor Air Interim Action Screening Levels (August 2017) EPA Vapor Intrusion Screening Levels (VISLs) generated using the VISL calculator (November 2018)</b>								
<b>2017 Residential Volatilization to Indoor Air Interim Action Screening Levels (<math>\mu\text{g}/\text{m}^3</math>)</b>								
Soil Vapor (including subslab) RIASL			110	340	2,100	170,000	7,600	Various
Soil Vapor (including subslab) TSRIASL			630	3,400	6,300	250,000	23,000	Various
<b>2017 Nonresidential Volatilization to Indoor Air Interim Action Screening Levels (<math>\mu\text{g}/\text{m}^3</math>)</b>								
Soil Vapor (including subslab) RIASL			260	800	3,100	250,000	11,000	Various
Soil Vapor (including subslab) RIASL <sub>12</sub>			510	1,600	6,100	250,000	22,000	Various
Soil Vapor (including subslab) TSRIASL <sub>12</sub>			1,800	16,000	18,000	250,000	67,000	Various
<b>EPA Vapor Intrusion Screening Levels (<math>\mu\text{g}/\text{m}^3</math>)</b>								
Target Residential Soil Gas Concentration (THQ = 1; TCR = 1.0E-5; GWT = 10)			120	374	2,090	174,000	3,480	Various
Target Commercial Soil Gas Concentration (THQ = 1; TCR = 1.0E-5; GWT = 10)			524	1,640	8,760	730,000	14,600	Various

- Screening Level/Criteria Exceeded
- BOLD** Value Exceeds Applicable Screening Level/Criteria
- ND Not detected at or above laboratory method detection limits (MDLs)
- bgs Below Ground Surface
- ( $\mu\text{g}/\text{m}^3$ ) Micrograms per Cubic Meter
- RIASL Recommended Interim Action Screening Levels
- TSRIASL Time Sensitive Recommended Interim Action Screening Levels
- RIASL<sub>12</sub> Nonresidential Recommended Interim Action Screening Levels appropriate for exposures less than 12 hours
- TSRIASL<sub>12</sub> Time Sensitive Recommended Interim Action Screening Levels appropriate for exposures less than 12 hours for structures not formerly residential homes
- GWT Groundwater Temperature in Degrees Celsius
- THQ Target Hazard Quotient for Non-Carcinogens
- TCR Target Risk for Carcinogens





13400 SCHAEFER HIGHWAY  
METROPOLITAN CHURCH OF GOD

FORMER UST BASIN CONTAINING:  
(3) 10,000-GALLON USTs  
(REMOVED 1998)

SB-1	
9/9/2019	
4.0 - 5.0'	
UNITS	ug/Kg
VOCs	<MDL
B(a)ANTH	300
CHRYSENE	400
FL	400
Py	600
OTHER PNA	<MDL
PCBs	<MDL
Cd	480
Cr	20,800
Pb	42,400

RESIDENTIAL

**LEGEND:**

- SUBJECT PROPERTY
  - APPROXIMATE FORMER/HISTORICAL SITE FEATURES
  - ELEC ELECTRIC
  - GAS GAS
  - LIMITS OF FORMER UST BASIN
  - 2001 EXCAVATION LIMITS
  - ▲ PAD MOUNTED TRANSFORMER
  - DUMPSTER
  - CATCH BASIN
  - UST
  - Ⓐ FORMER GASOLINE SERVICE STATION
  - Ⓑ FORMER SERVICE/HISTORICAL ELECTRICAL SUBSTATION BUILDING
  - Ⓒ FORMER USED CAR SALES/SERVICE BUILDING
  - Ⓓ FORMER RESTAURANT
  - Ⓔ FORMER STOREFRONTS AND ASSOCIATED GARAGE
  - Ⓕ FORMER OFFICE BUILDING
  - Ⓖ FORMER SUBSTATION BUILDING
  - Ⓗ FORMER FILLING STATION
  - Ⓢ 2001 BEA SOIL BORING
  - ▲ 2001 EXCAVATION SAMPLE
  - SOIL BORING
  - SOIL BORING / SOIL GAS SAMPLE
- 
- Cd CADMIUM
  - Cr CHROMIUM
  - Pb LEAD
  - E ETHYLBENZENE
  - B(a)ANTH BENZO(a)ANTHRACENE
  - 2-M 2-METHYLNAPHTHALENE
  - NAPH NAPHTHALENE
  - FL FLUORANTHENE
  - Py PYRENE
  - n-PROP n-PROPYLBENZENE
  - n-BUTYLB n-BUTYLBENZENE
  - sec-BUTYLB sec-BUTYLBENZENE
  - VOCs VOLATILE ORGANIC COMPOUNDS
  - PNA POLYNUCLEAR AROMATIC COMPOUNDS
  - PCBs POLYCHLORINATED BIPHENYLS
  - MDL METHOD DETECTION LIMIT
  - UNITS μg/Kg (UNLESS NOTED)
  - VALUE EXCEEDS APPLICABLE CRITERIA
- NOTES: REFER TO TABLES FOR SPECIFIC COMPOUNDS ANALYZED

13634 WEST GRAND RIVER AVENUE  
McDONALDS

SCHAEFER HIGHWAY

(3) FORMER GASOLINE USTs  
(IDENTIFIED IN FORMER 1926 SANBORN MAP)

(2) FORMER APPROXIMATELY 2,000-GALLON USTs  
(REMOVED 2001)

(3) FORMER APPROXIMATELY 1,000-GALLON USTs  
(REMOVED 2001)

SB/SG-2	
9/9/2019	
5.0 - 6.0'	
UNITS	ug/Kg
n-BUTYLB	2,400
sec-BUTYLB	800
E	3,700
2-M	12,000
NAPH	7,000
n-PROP	9,300
OTHER VOCs	<MDL
2-M	6,700
NAPH	3,900
OTHER PNA	<MDL
Pb	9,390

GRAND RIVER AVENUE

13544 WEST GRAND RIVER AVENUE  
VACANT COMMERCIAL BUILDING

13611 WEST GRAND RIVER AVENUE  
GALAXY CONEY ISLAND

13150 SCHAEFER HIGHWAY  
MOBIL GASOLINE DISPENSING STATION

13119 SCHAEFER HIGHWAY  
CITGO GASOLINE DISPENSING STATION



**FIGURE 3**  
SOIL BORING / SOIL GAS SAMPLE LOCATION MAP  
WITH SOIL ANALYTICAL RESULTS

PROJ: CVS PROPERTY 13580 GRAND RIVER AVENUE DETROIT, MI		
THIS IS NOT A LEGAL SURVEY	DRN BY: ES	DATE: 9/16/2019
VERIFY SCALE	CHKD BY: TH	SCALE: 1" = 40'
IF NOT 1" ON THIS SHEET, ADJUST SCALES ACCORDINGLY.	FILE NAME:	01-11327-0-002F00R00

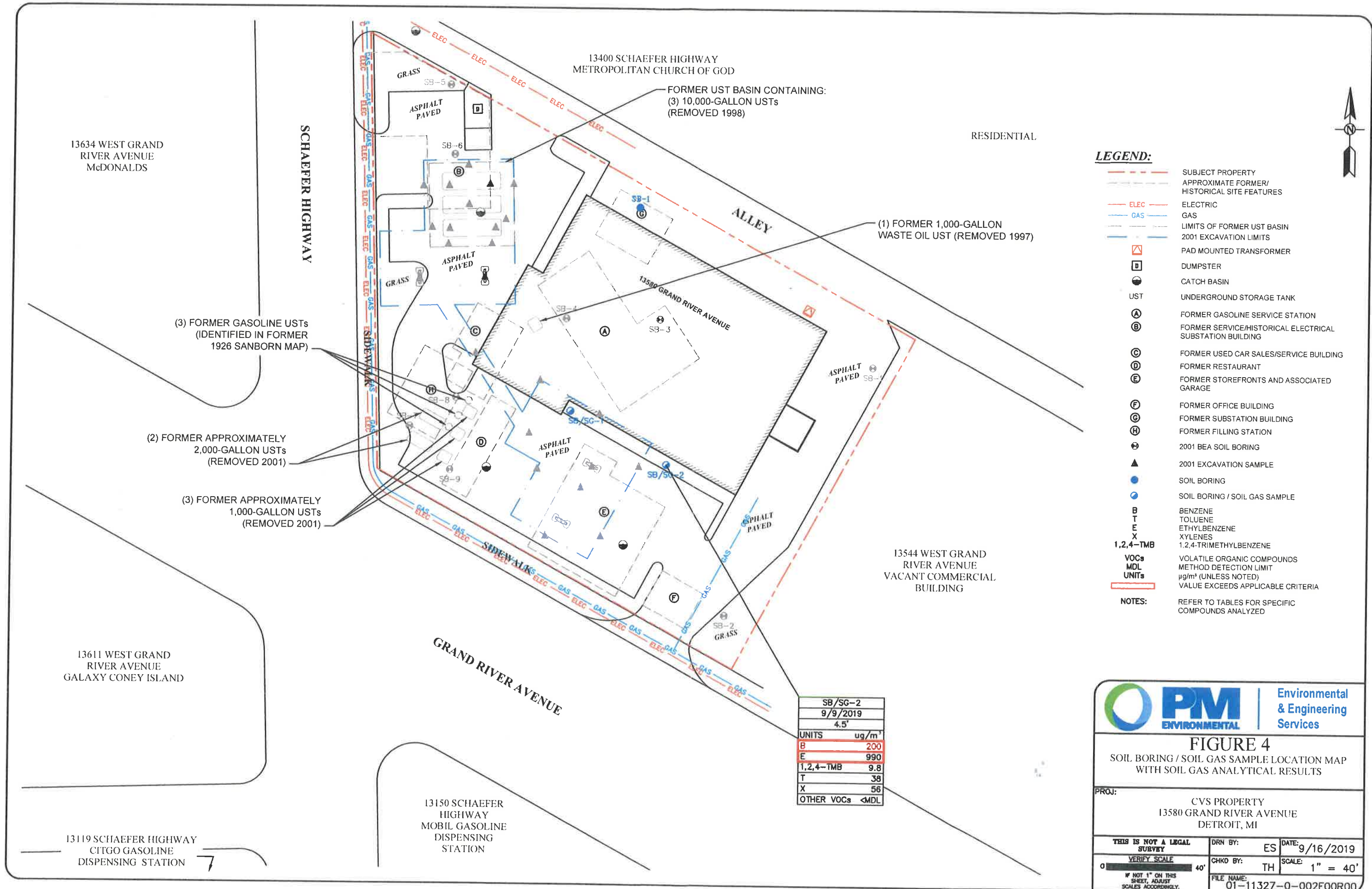

- LEGEND:**
- SUBJECT PROPERTY
  - APPROXIMATE FORMER/HISTORICAL SITE FEATURES
  - ELEC ELECTRIC
  - GAS GAS
  - LIMITS OF FORMER UST BASIN
  - 2001 EXCAVATION LIMITS
  - PAD MOUNTED TRANSFORMER
  - D DUMPSTER
  - CATCH BASIN
  - UST UNDERGROUND STORAGE TANK
  - A FORMER GASOLINE SERVICE STATION
  - B FORMER SERVICE/HISTORICAL ELECTRICAL SUBSTATION BUILDING
  - C FORMER USED CAR SALES/SERVICE BUILDING
  - D FORMER RESTAURANT
  - E FORMER STOREFRONTS AND ASSOCIATED GARAGE
  - F FORMER OFFICE BUILDING
  - G FORMER SUBSTATION BUILDING
  - H FORMER FILLING STATION
  - ⊕ 2001 BEA SOIL BORING
  - ▲ 2001 EXCAVATION SAMPLE
  - SOIL BORING
  - SOIL BORING / SOIL GAS SAMPLE
  - B BENZENE
  - T TOLUENE
  - E ETHYLBENZENE
  - X XYLENES
  - 1,2,4-TMB 1,2,4-TRIMETHYLBENZENE
  - VOCs VOLATILE ORGANIC COMPOUNDS
  - MDL METHOD DETECTION LIMIT
  - UNITS μg/m<sup>3</sup> (UNLESS NOTED)
  - VALUE EXCEEDS APPLICABLE CRITERIA
  - NOTES:** REFER TO TABLES FOR SPECIFIC COMPOUNDS ANALYZED



**FIGURE 4**  
SOIL BORING / SOIL GAS SAMPLE LOCATION MAP  
WITH SOIL GAS ANALYTICAL RESULTS

PROJ: CVS PROPERTY  
13580 GRAND RIVER AVENUE  
DETROIT, MI

THIS IS NOT A LEGAL SURVEY	DRN BY: ES	DATE: 9/16/2019
VERIFY SCALE	CHKD BY: TH	SCALE: 1" = 40'
IF NOT 1" ON THIS SHEET, ADJUST SCALES ACCORDINGLY.		
FILE NAME: 01-11327-0-002F00R00		

13634 WEST GRAND RIVER AVENUE  
McDONALDS

SCHAEFER HIGHWAY

13400 SCHAEFER HIGHWAY  
METROPOLITAN CHURCH OF GOD

RESIDENTIAL

ALLEY

(1) FORMER 1,000-GALLON WASTE OIL UST (REMOVED 1997)

13580 GRAND RIVER AVENUE

13544 WEST GRAND RIVER AVENUE  
VACANT COMMERCIAL BUILDING

GRAND RIVER AVENUE

13150 SCHAEFER HIGHWAY  
MOBIL GASOLINE DISPENSING STATION

13611 WEST GRAND RIVER AVENUE  
GALAXY CONEY ISLAND

13119 SCHAEFER HIGHWAY  
CITGO GASOLINE DISPENSING STATION