

1 2 3 4 5 6 7 8 9 10 11 12 13 14 15 16 17 18 19 20 21 22 23 24 25 26 27 28 29 30 31 32 33 34 35 36 37 38 39 40 41 42 43 44 45 46 47 48 49 50

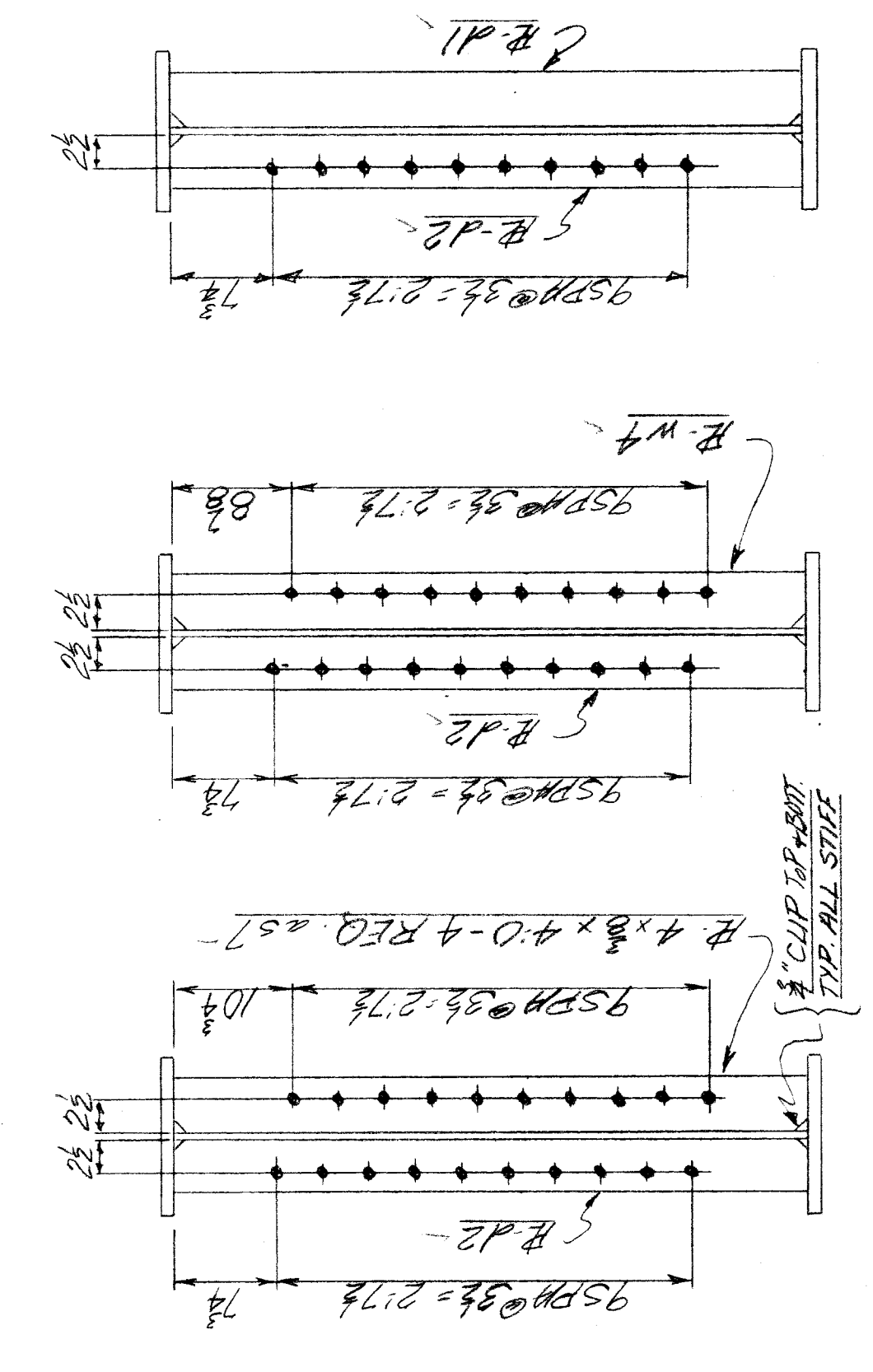
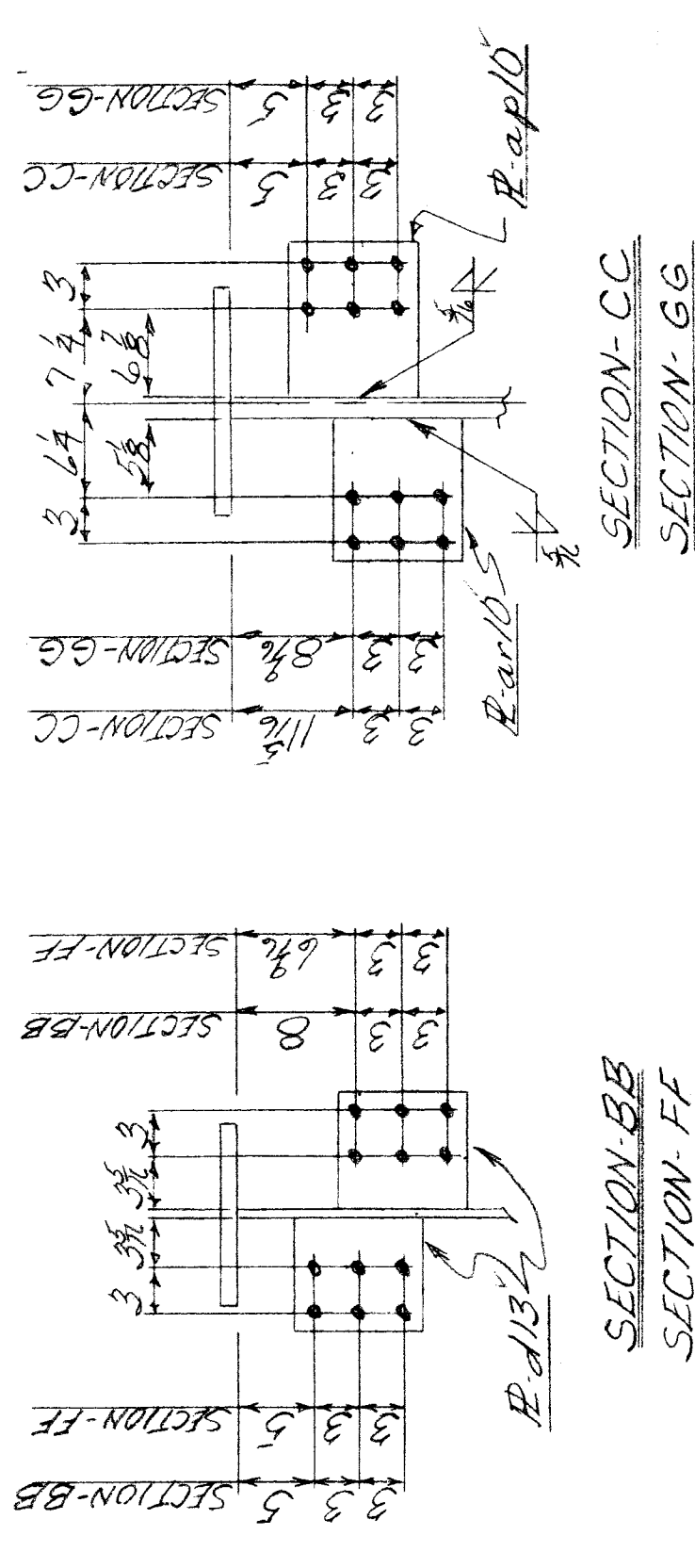
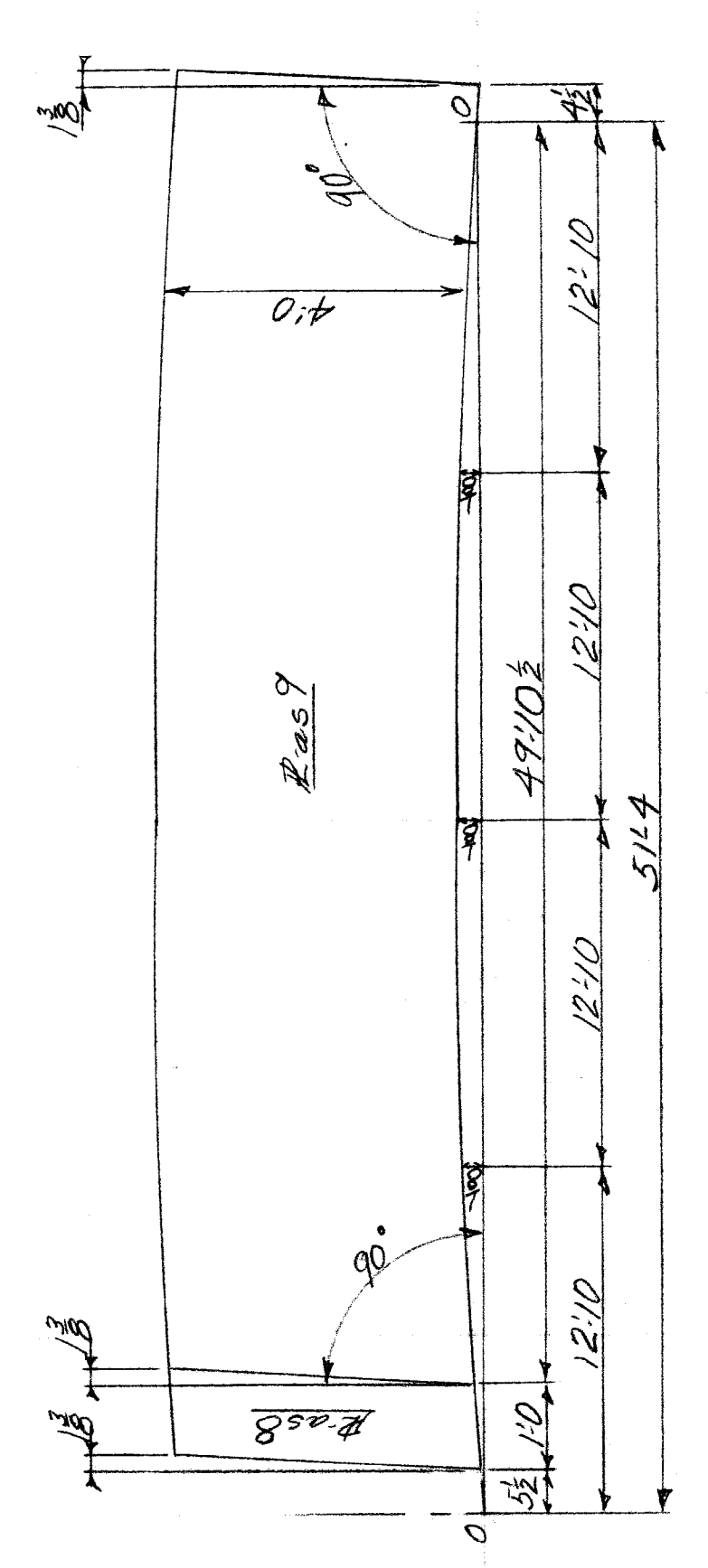
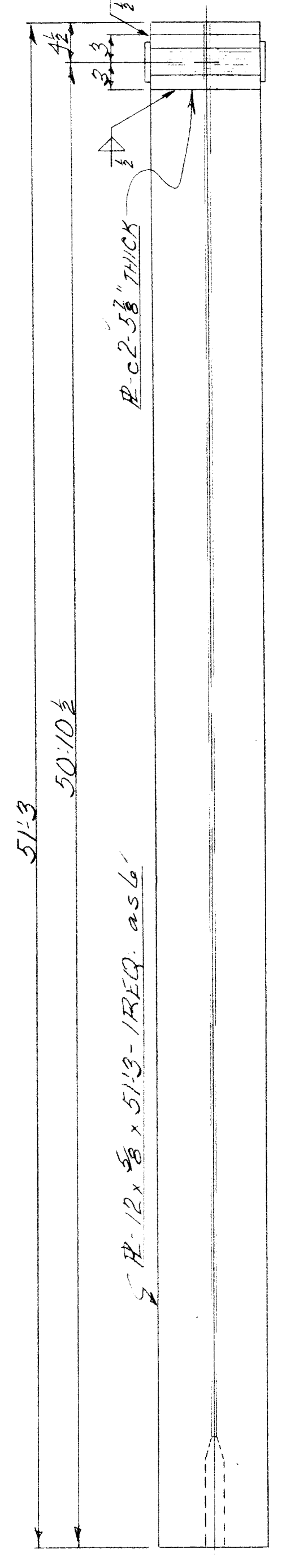
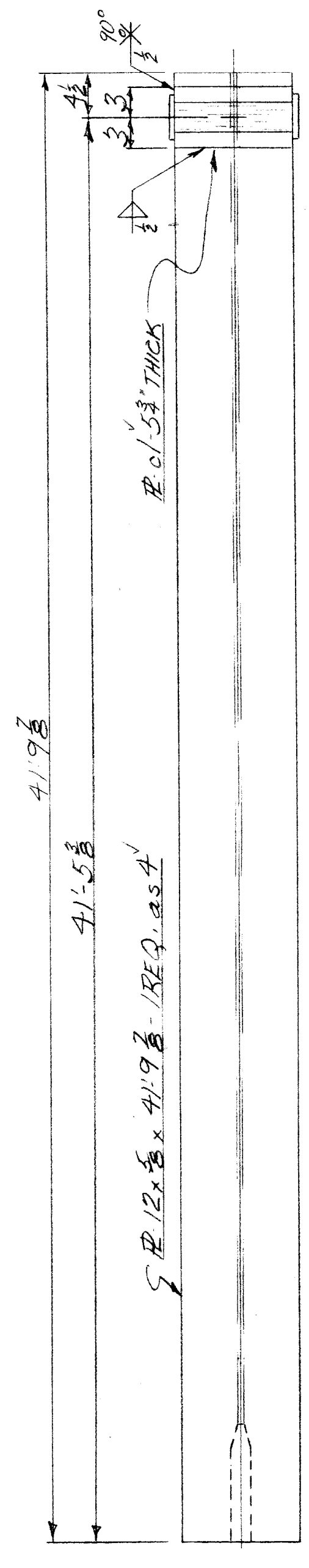
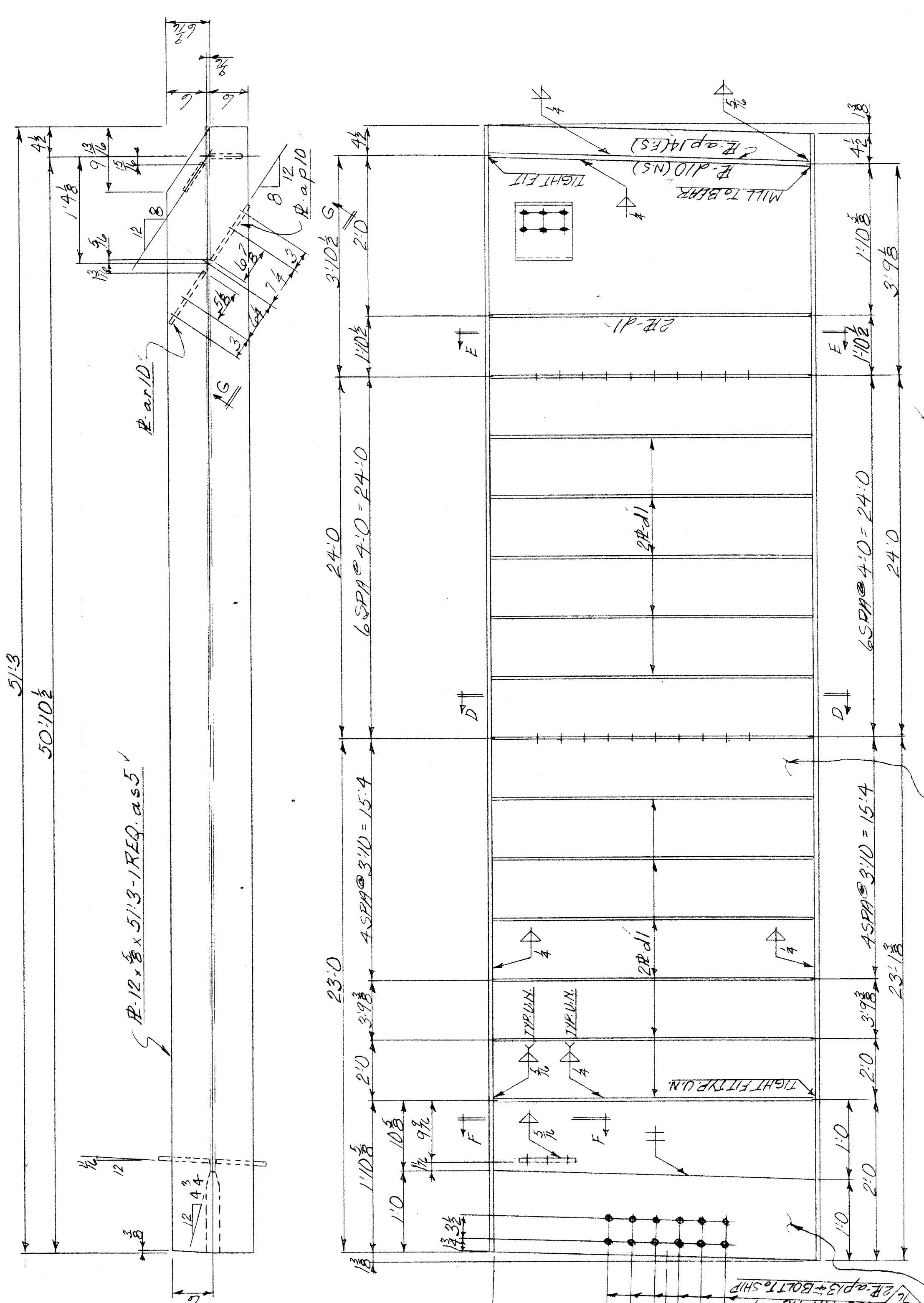
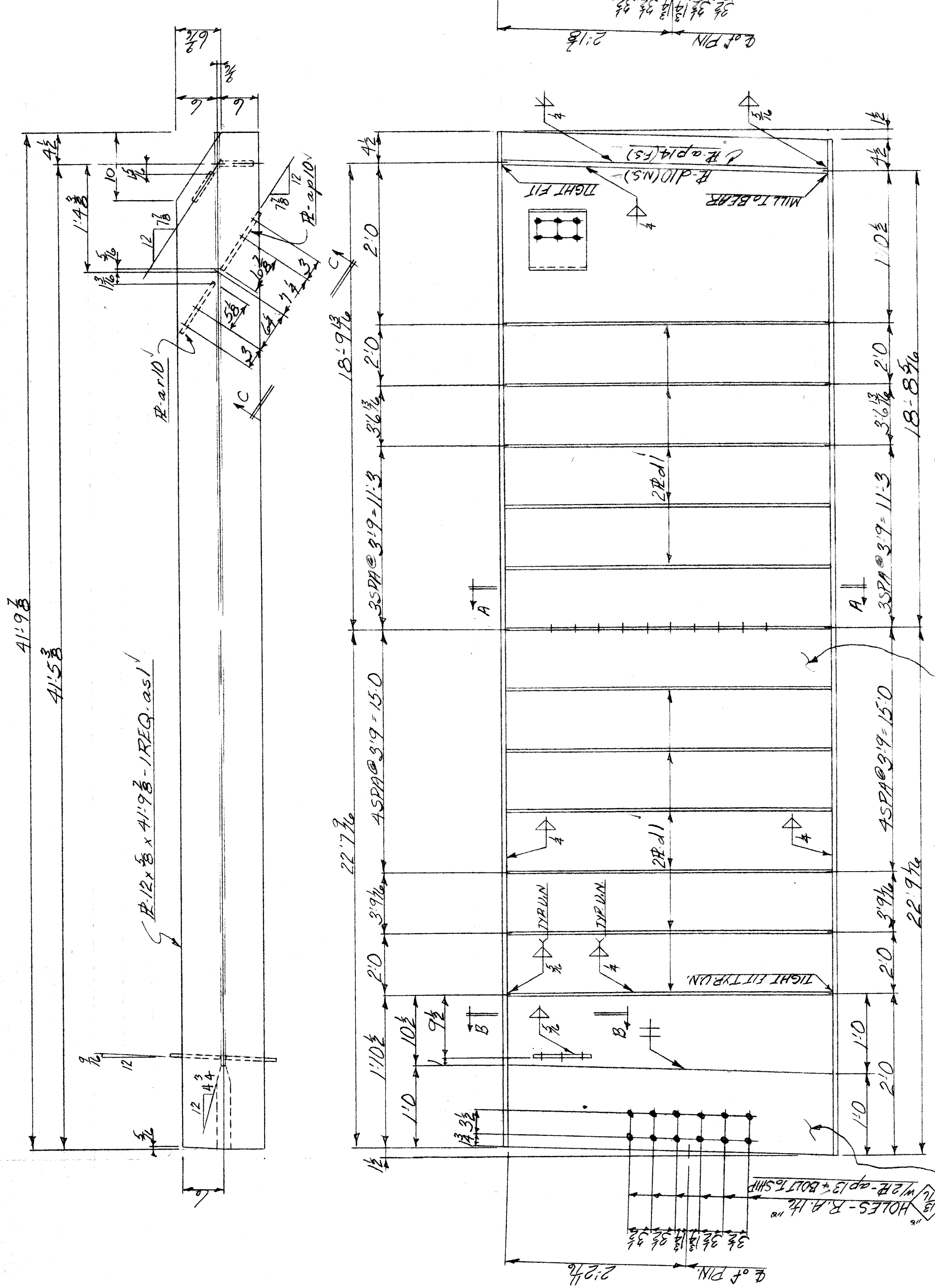

ONE GIRDER - B37 (C)

CAMBER DIAGRAM GIRDER - B37

PLATE LAYOUT GIRDER - B37

<p>VINCENNES STEEL Div. of NOVO Industrial Corp. Vincennes, Ind.</p>		<p>Checked Approved Revised</p>
<p>WAYNE COUNTY ROAD COMMISSIONERS DETROIT, MICHIGAN MT. ELLIOTT - MOUND ROAD GRADE SEPARATION JOB NO. 246</p>		<p>Drawn Checked Approved Revised</p>
<p>SEE NOTES SHEET 3 Edge Distance - 1 1/2" MIN. Contact Surfaces Shop - None Field - None</p>		<p>Point Name Holes - Rivets Rivets - Bolts</p>
<p>SECTION-BB SECTION-BB SECTION-BB SECTION-CC SECTION-CC SECTION-CC</p>		<p>1-69 1-69 1-69</p>

1 2 3 4 5 6 7 8 9 10 11 12 13 14 15 16 17 18 19 20 21 22 23 24 25 26 27 28 29 30 31 32 33 34 35 36 37 38 39 40 41 42 43 44 45 46 47 48 49 50

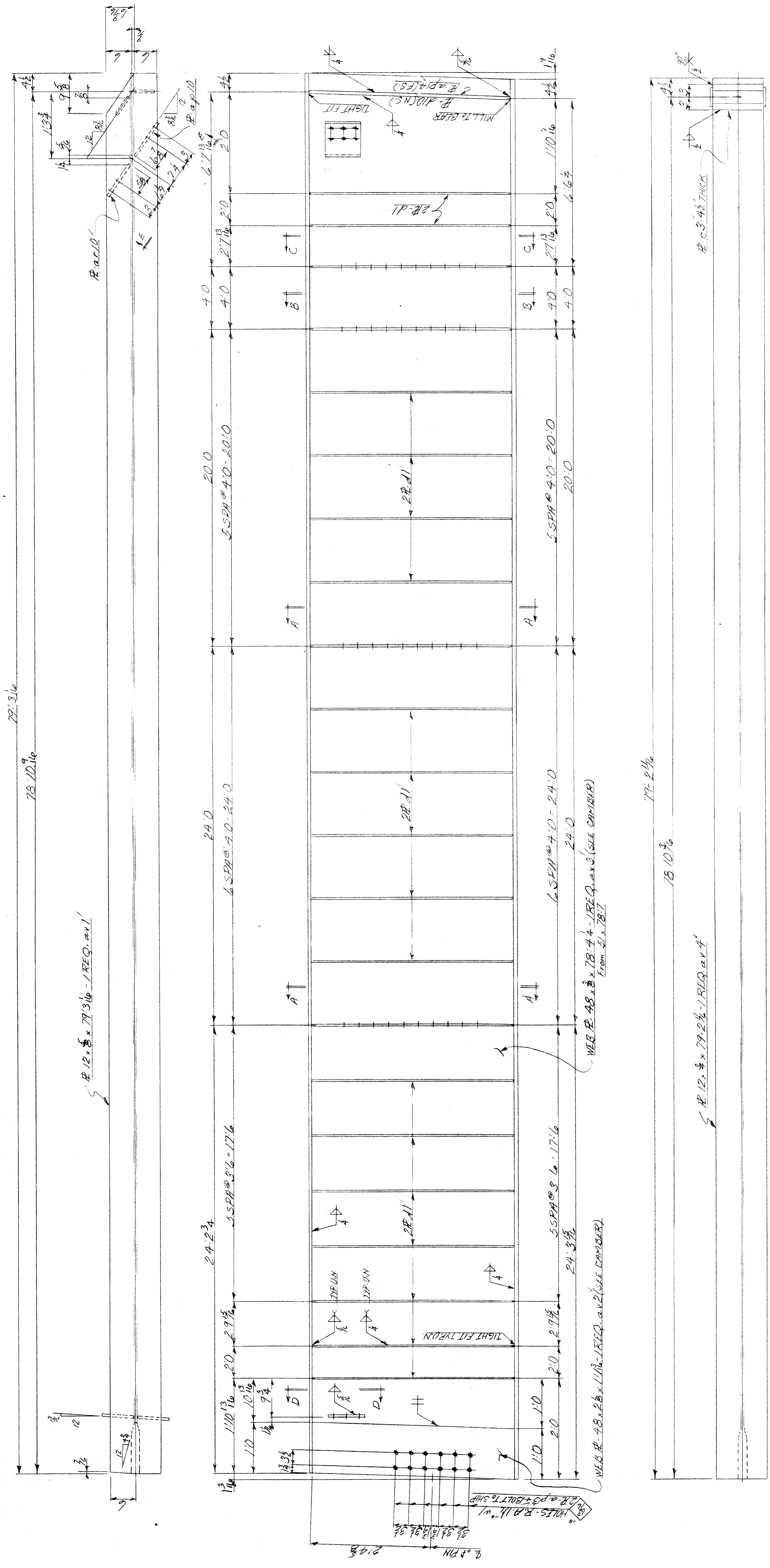

ONE GIRDER - A40 ①

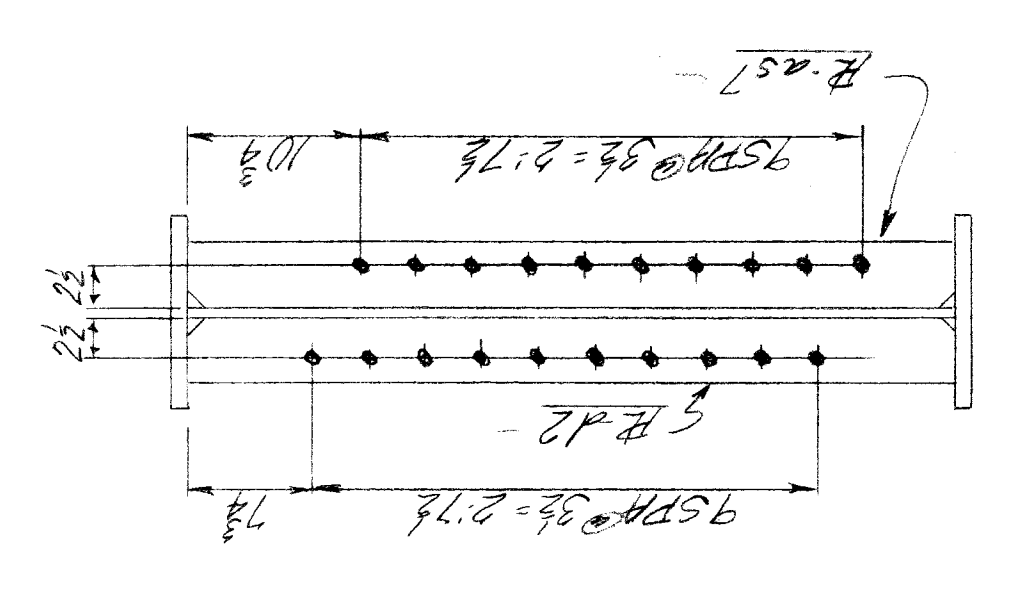

SECTION-AA

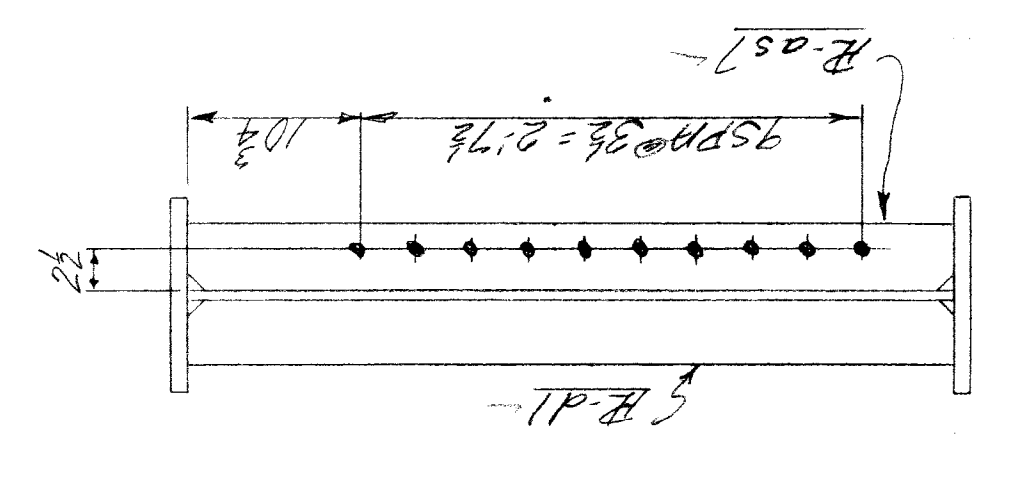

SECTION-BB

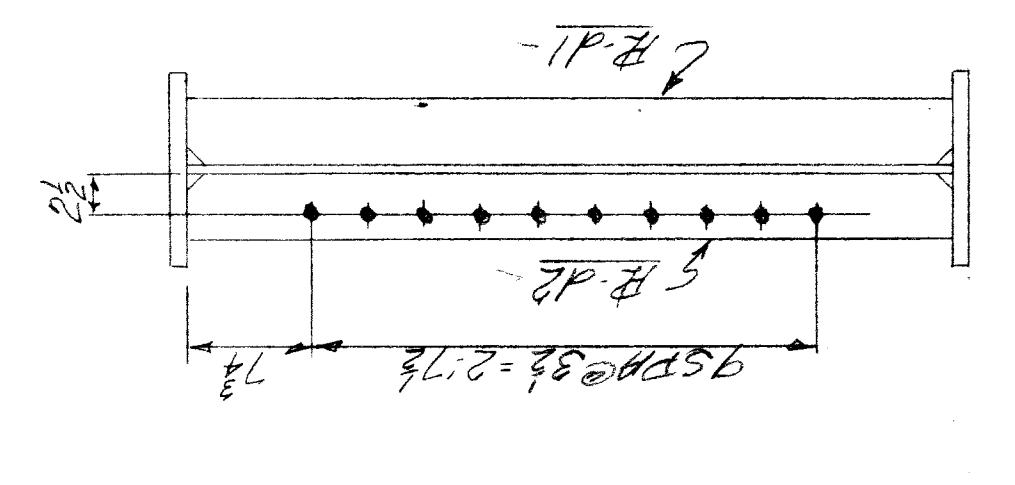

SECTION-CC

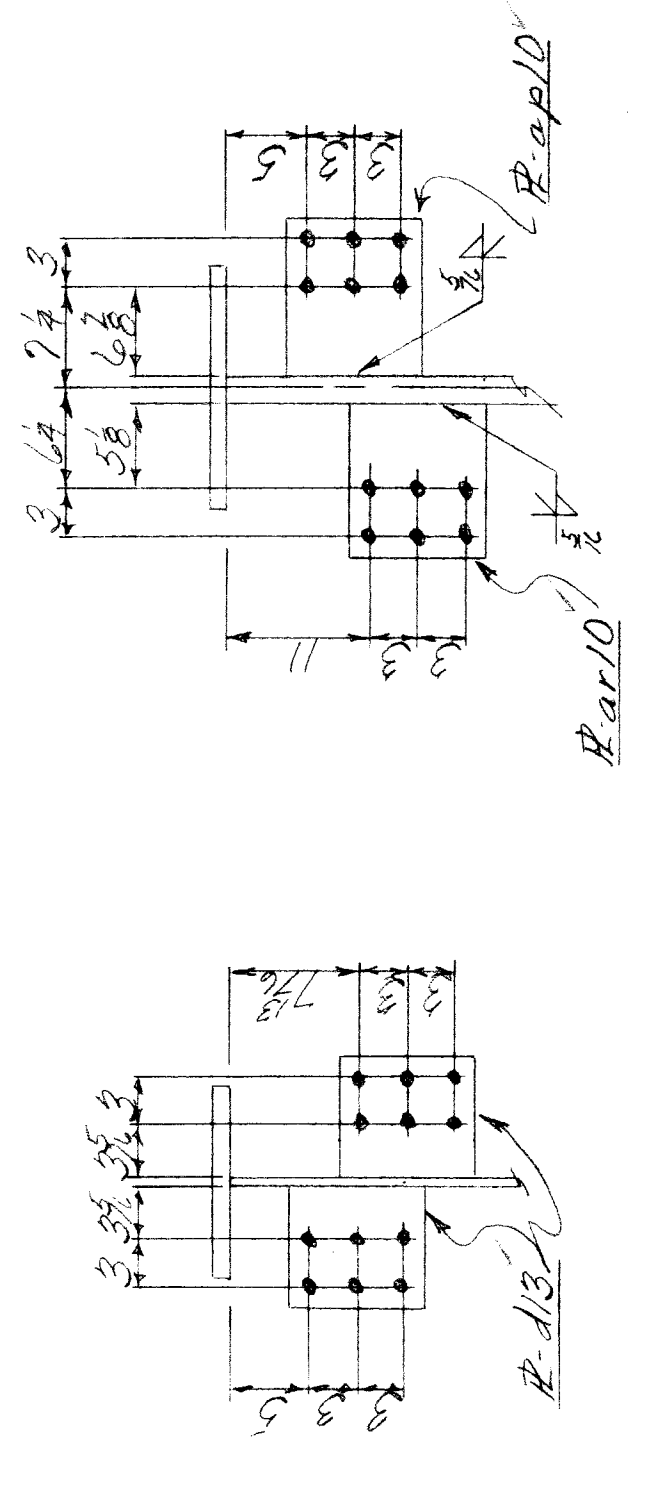

SECTION-DD

SECTION-EE

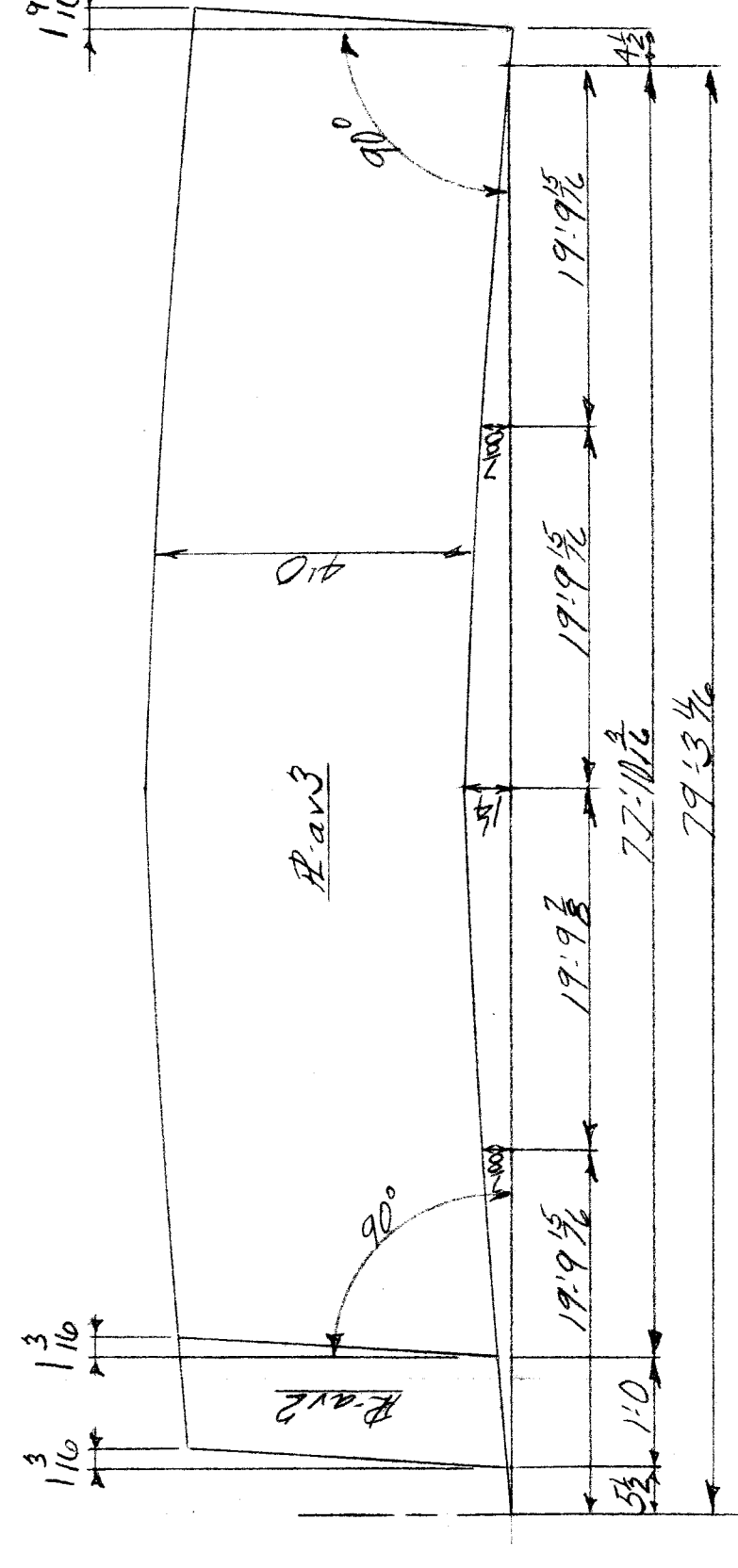

CAMBER DIAGRAM

SEE NUTS SHEET 3	WAYNE COUNTY ROAD COMMISSIONERS	VINCENNES STEEL Div. of NOVO Industrial Corp. Vincennes, Ind. DETROIT, MICHIGAN MT. ELLIOTT - MOUND ROAD GRADE SEPARATION JOB NO. 246	Checked	Approved	Revised
Edge Distance - 1 1/2" UN.	Sharp-Angle		Drawn		
Contact Surface	Field-Angle		1-69	1-69	
Paint					
Holes - 3/4" UN.					
Rivets - Bolts					

48 49 50

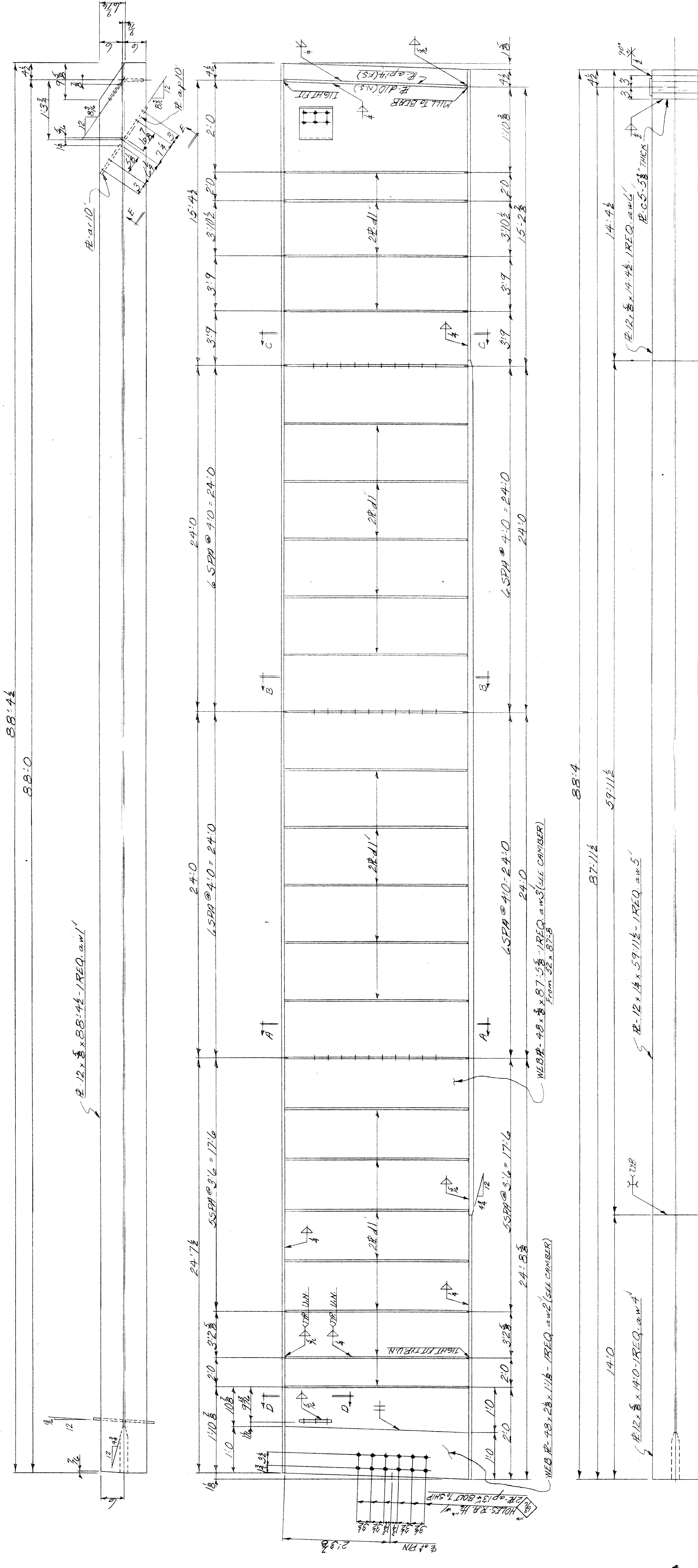

ONE GIRDER-A41 ©

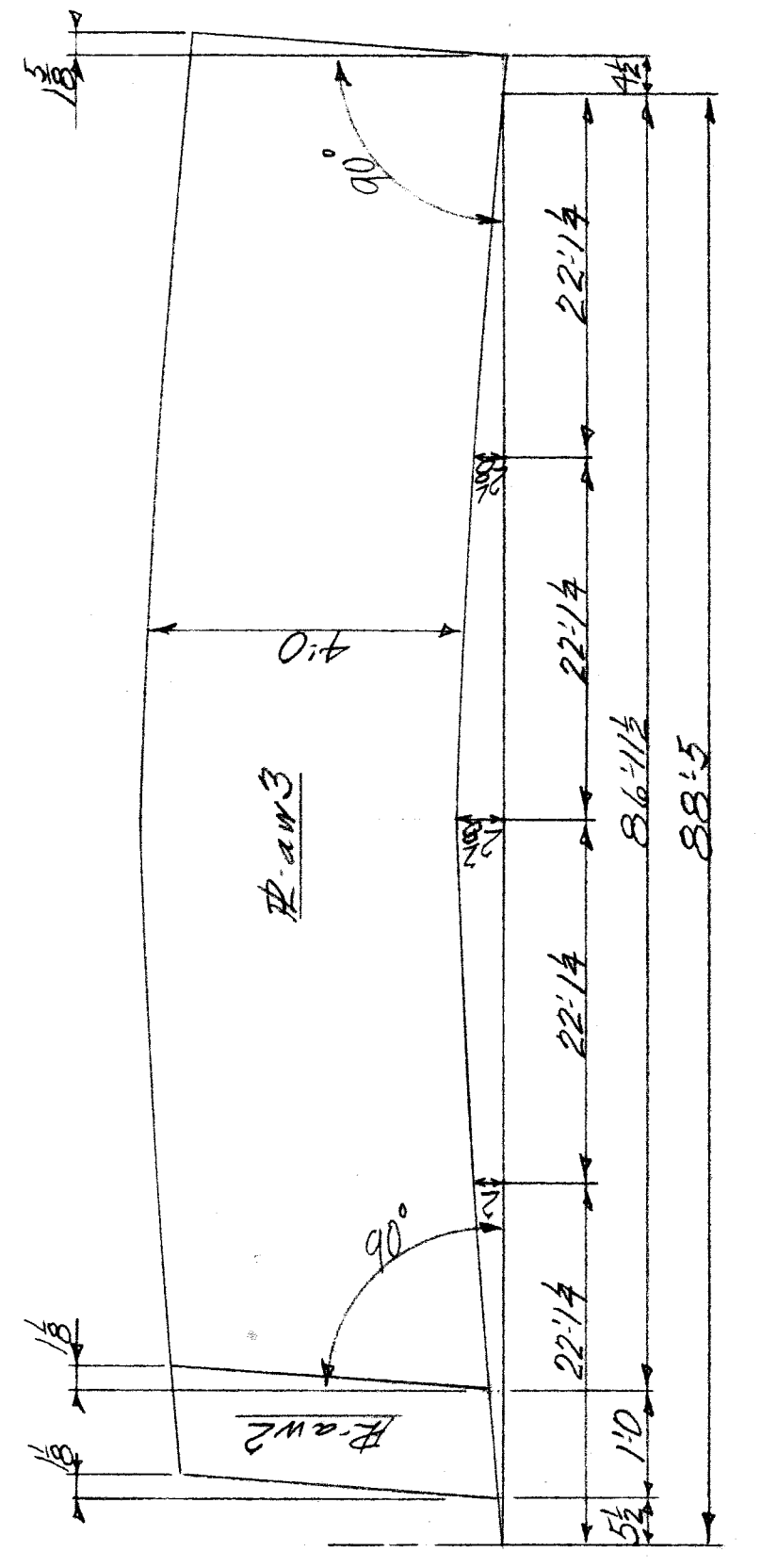
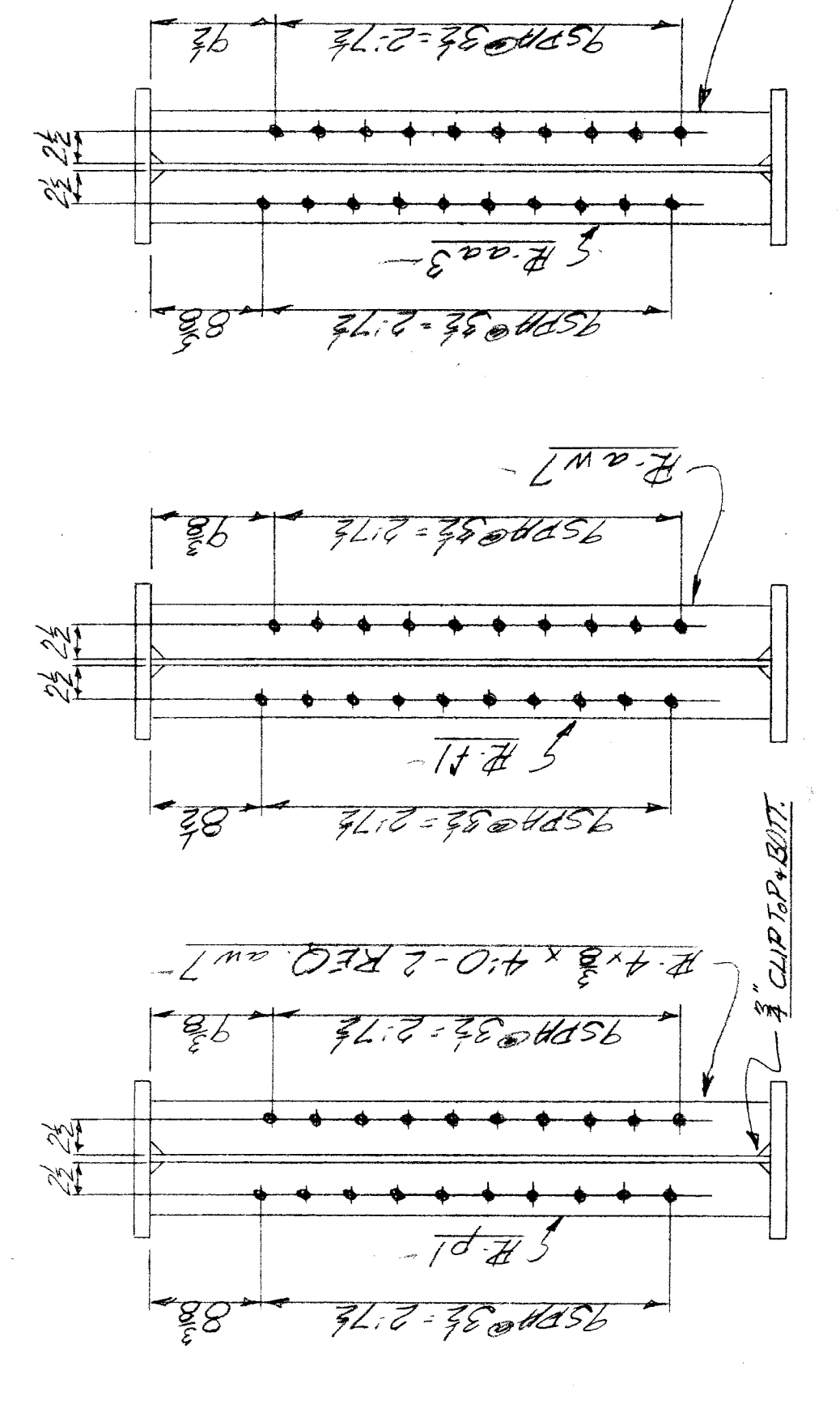
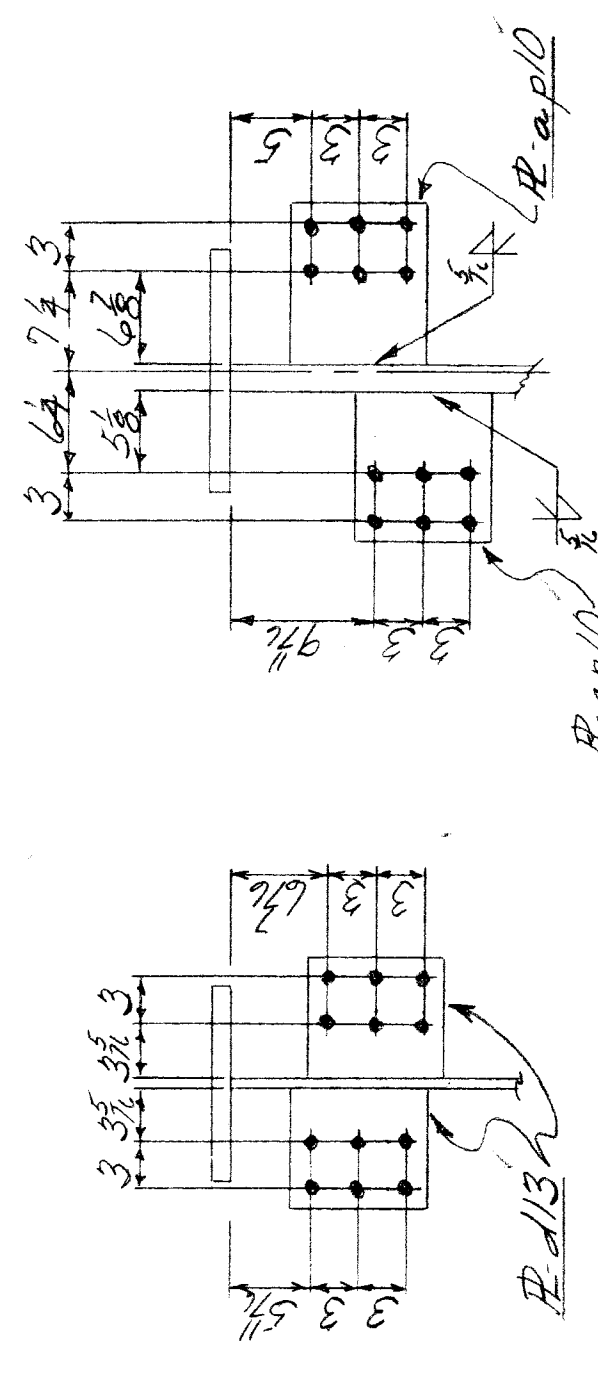

SEE NOTES SHEET 3

Edge Distance - 1 1/2" MIN

Contact Surface - Shop - None

Field - None

Paint - None

Holes - 1/2" DIA

Rivets - Bolts

Checked - [Signature]

Approved - [Signature]

Revised - [Signature]

VINCENNES STEEL

Div. of NOVO Industrial Corp.

Vincennes, Ind.

WAYNE COUNTY ROAD COMMISSION

INDIANAPOLIS, INDIANA

ELLIOTT MOUND ROAD

GRADE SEPARATION

JOB NO. 248

Drawn - [Signature]

Checked - [Signature]

Approved - [Signature]

Revised - [Signature]

Contr. No. 4-7

Sh. 41

SECTION-AA SECTION-BB SECTION-CC

CAMBER DIAGRAM

1 2 3 4 5 6 7 8 9 10 11 12 13 14 15 16 17 18 19 20 21 22 23 24 25 26 27 28 29 30 31 32 33 34 35 36 37 38 39 40 41 42 43 44 45 46 47 48 49 50

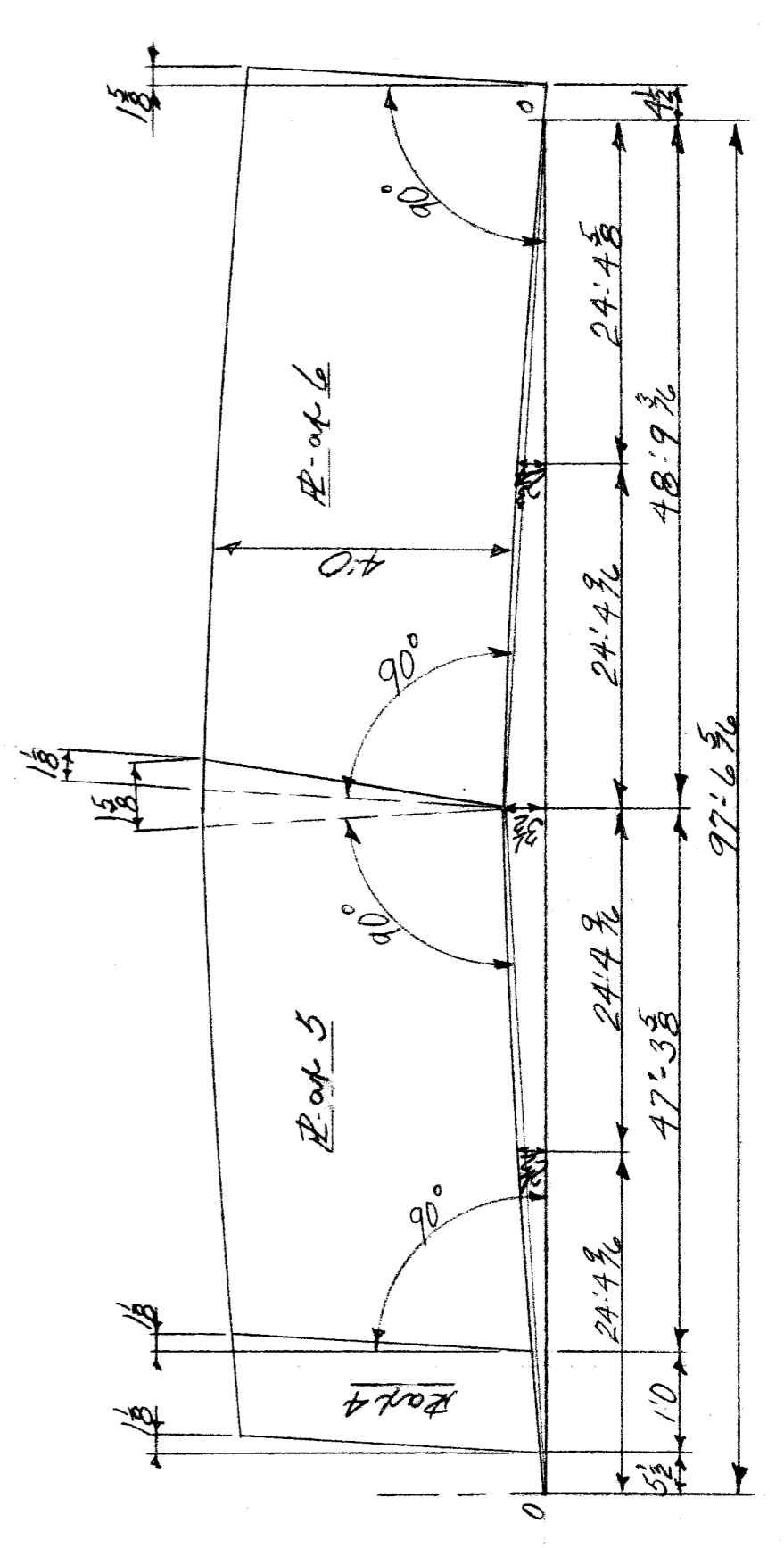
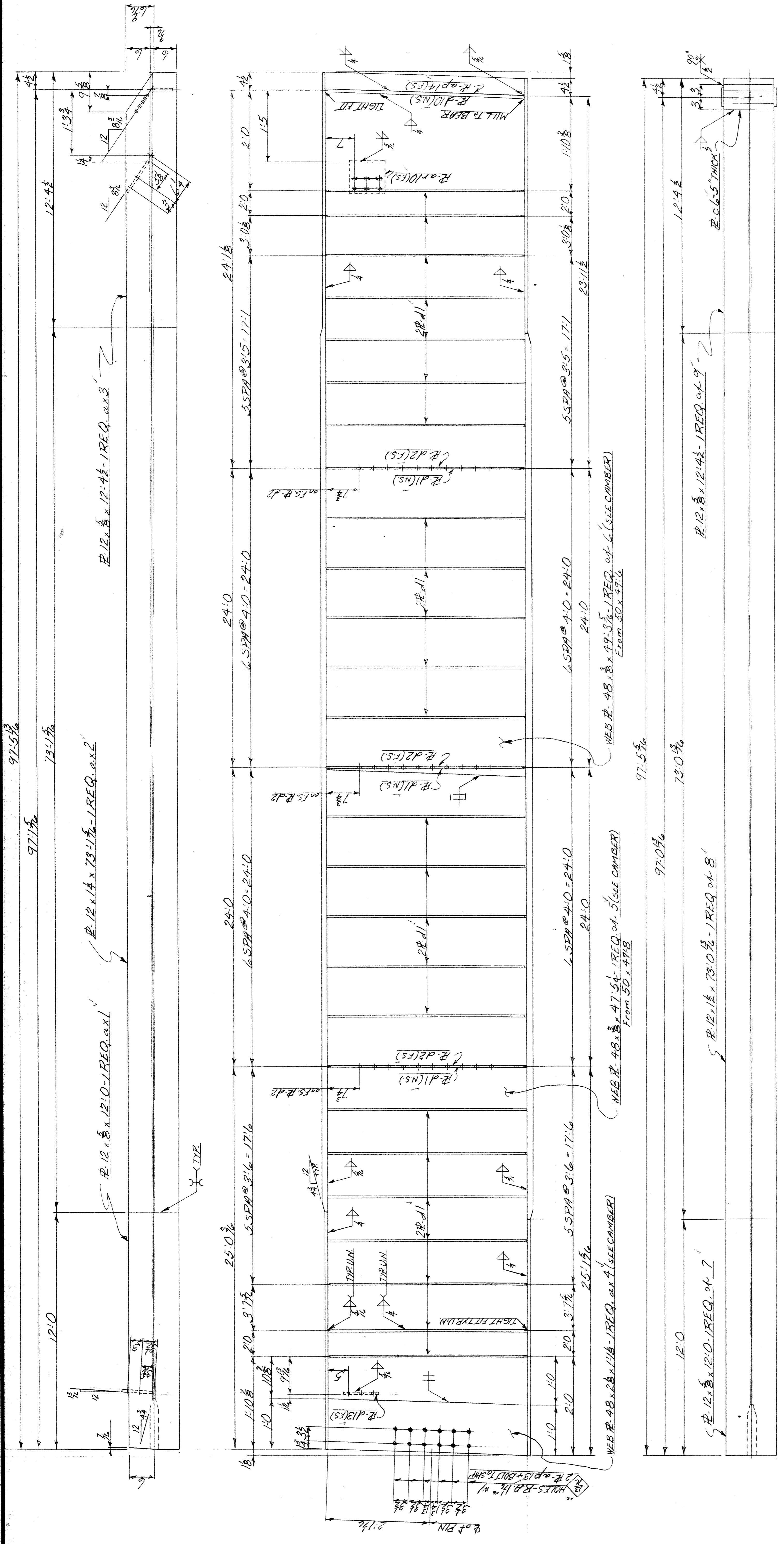

VINCENNES STEEL
Div. of NOVO Industrial Corp.
Vincennes, Ind.

WAYNE COUNTY ROAD COMMISSIONERS
DETROIT, MICHIGAN
MT. ELLIOTT - MOUND ROAD
GRADE SEPARATION
JOB NO. 246

Drawn	Checked	Approved	Revised
1/69	1/69	1/69	

Form: Name: 1/69
Holes: 2 1/2" DIA.
Rivets-Bolts: 1/2" DIA.

SEE NOTES: 2

Edge Distance: 1/4" DIA
Contact Surface: Shop - No. 2
Field - No. 2

Contr. No. 467 Sh. 42 of

1 2 3 4 5 6 7 8 9 10 11 12 13 14 15 16 17 18 19 20 21 22 23 24 25 26 27 28 29 30 31 32 33 34 35 36 37 38 39 40 41 42 43 44 45 46 47 48 49 50

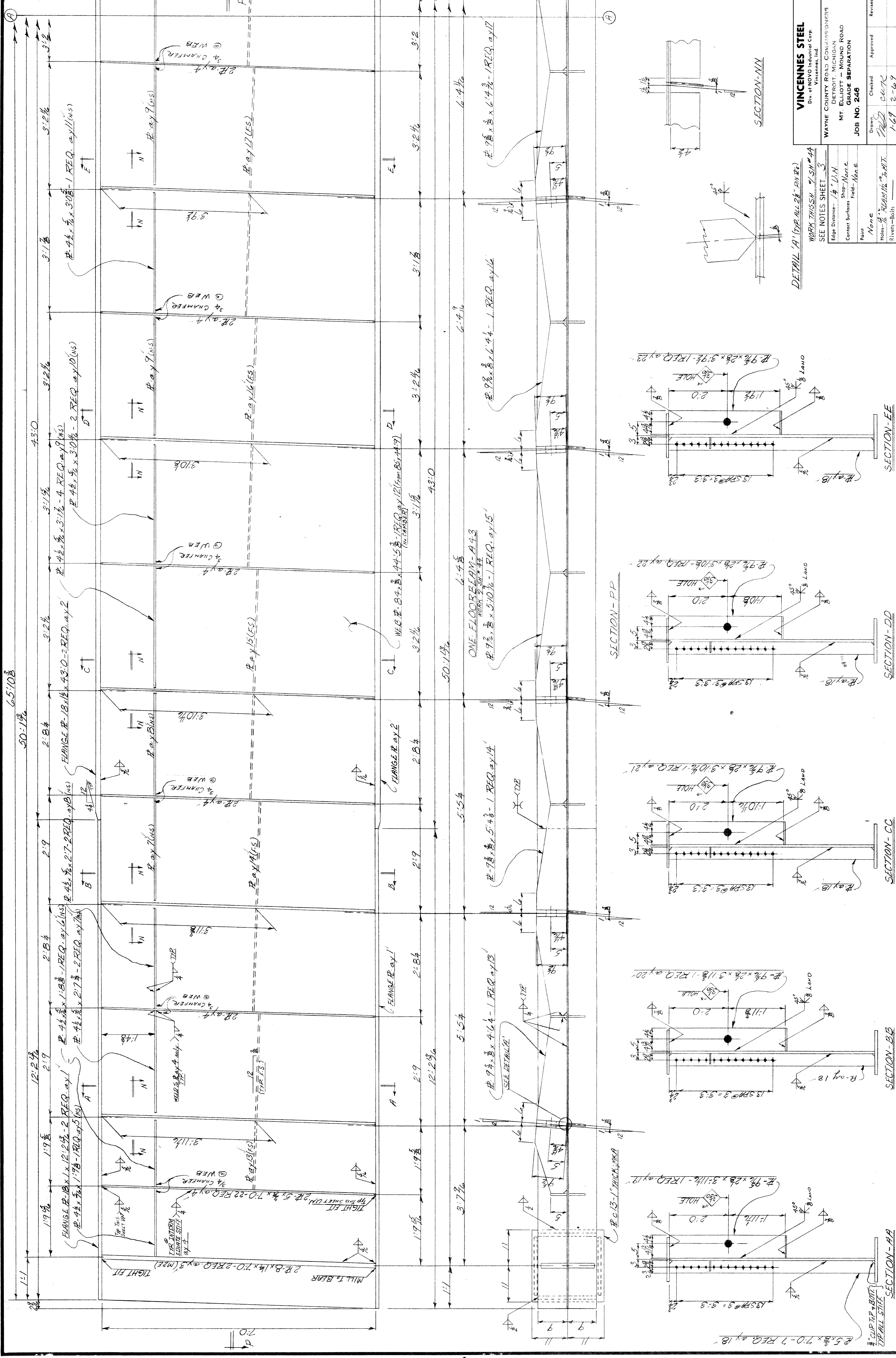

VINCENNES STEEL
Div. of INCO Industrial Corp.
Vincennes, Ind.

WAYNE COUNTY ROAD COMMISSIONERS
DETROIT, MICHIGAN
MT. ELLIOTT - MOUND ROAD
GRADE SEPARATION
JOB NO. 246

WORK THRESHOLD: 1" SP#44
SEE NOTES SHEET 3

Edge Distance: 7/8" DIA
Corner Surface: Shop - None, Field - None
Paint: None
Holes: 1/8" DIA MIN 1/8" MT.
Rivet - Bolts: 1/2" 2-67

Drawn: [Signature]
Checked: [Signature]
Approved: [Signature]

Contr. No. 467 Sh. 43

1 2 3 4 5 6 7 8 9 10 11 12 13 14 15 16 17 18 19 20 21 22 23 24 25 26 27 28 29 30 31 32 33 34 35 36 37 38 39 40 41 42 43 44 45 46 47 48 49 50

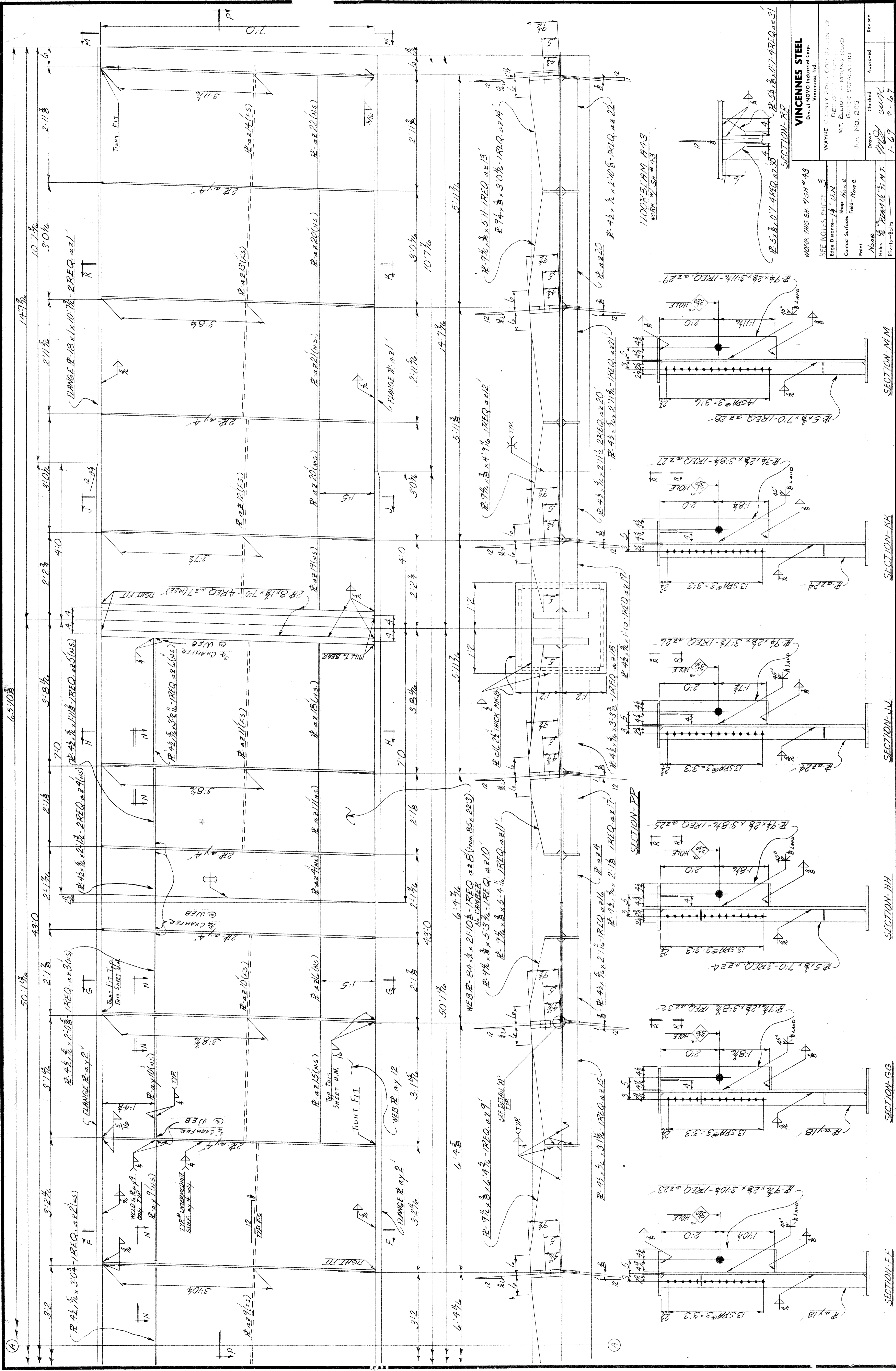

VINCENNES STEEL
Div. of NOVO Industrial Corp.
Vincennes, Ind.

WAYNE COUNTY POLICE DEPARTMENT
DEPT. OF PUBLIC SAFETY
MT. ELLIOTT WINDING ROAD
GRASSY SEPARATION
JOB NO. 243

WORK THIS SH. 1/4" # 43

SEE MOLLS SHEET 3
Edge Distance - 1 1/2"
Contact Surfaces Shop - None
Field - None

Paint None
Holes - 1/2" RIVETS
Rivets - Bolts

Drawn: *[Signature]*
Checked: *[Signature]*
Approved: *[Signature]*
Revised: *[Signature]*

1-69 2-69 4-69

Contr. No. 467 SH. 44

SECTION-FF SECTION-EE SECTION-GG SECTION-HH SECTION-IJ SECTION-KK SECTION-LL SECTION-MM SECTION-NN SECTION-PP SECTION-RR SECTION-SS SECTION-TT SECTION-UV SECTION-VV SECTION-WW SECTION-XX SECTION-YY SECTION-ZZ